

手工测量可能有误差，请与实物为准。



Cleanroom



ESD Medical



Lab



Sit-Stand

### Benefits for standing chair

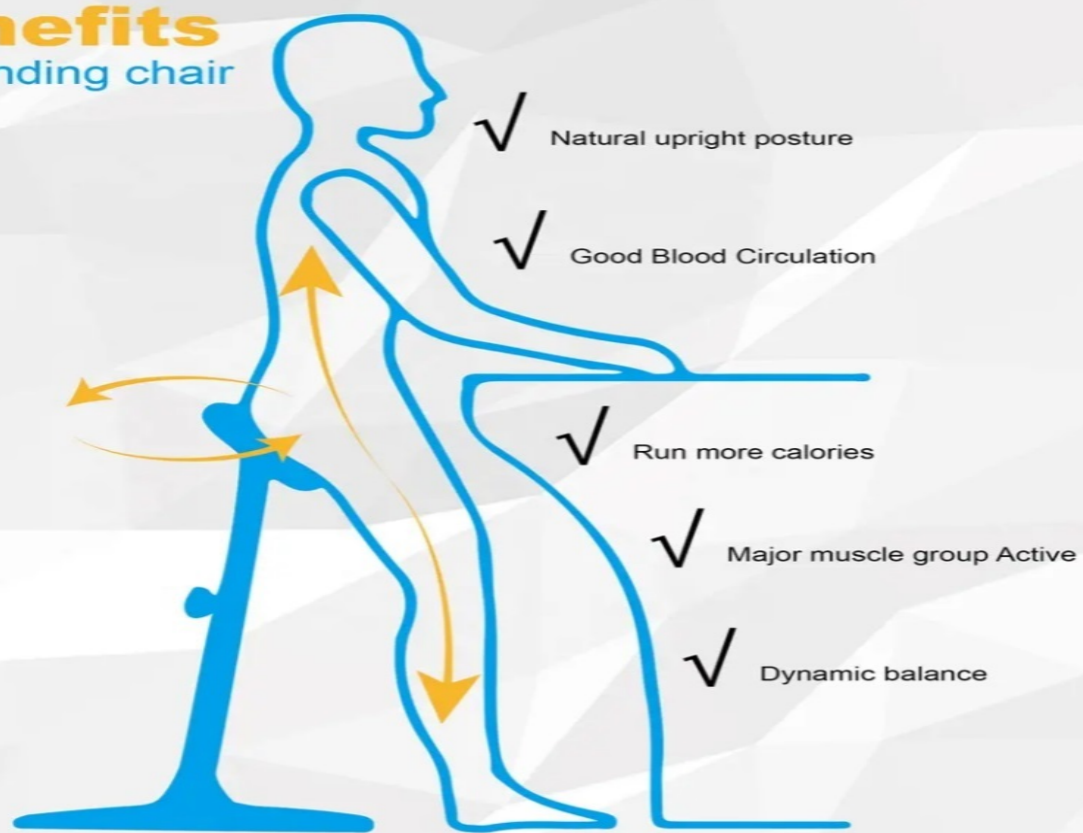

# Sit-Stand



Relief from stress and strain for people who cannot sit down to work.

Sit stands take the weight off legs and the angle of the seat opens hips to improve blood circulation while maintaining the back's natural alignment. Sit Stands provide a sustainable, comfortable working posture similar to standing without the undo stress on the body.

Sit Stands are not intended as a place to sit for extended periods of time, but rather provide an opportunity to experience periods of relief while maintaining high levels of productivity and encouraging a healthy work environment.

Our solutions for standing work give you the perfect support for any activity that cannot be undertaken while sitting down. Our standing rests range from simple supports for short-term stress-relief up to flexible standing rests that allow you to stand for prolonged periods without any signs of fatigue

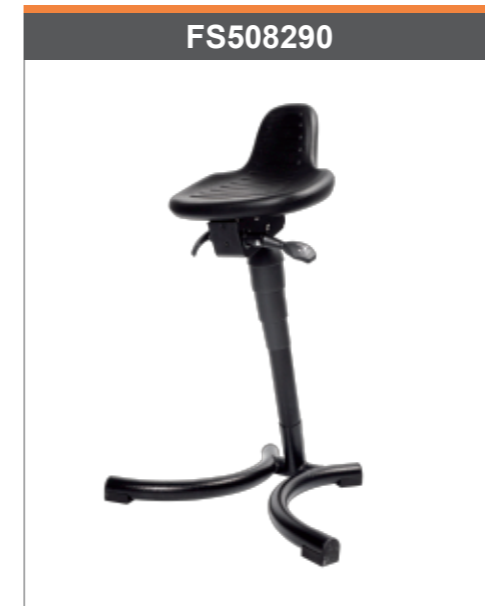

FS508290

## Product description

- Material: Vinyl/High elastic sponge / Eucalyptus wood
- Function: Seat forward tilt adjustment/up and down adjustment
- Seat height adjustment range: 620-870mm (distance from seat to ground)
- Base: Φw600\*d460mm / High-quality cold-rolled steel pipe stamping forming, spraying
- Wheels: Fixed
- ESD Version: system resistance 10<sup>4</sup>-10<sup>9</sup>Ω

Model	Seat Size (w*d)	Back Size (w*d)
FS508290	330 x 230mm	170 x 150mm

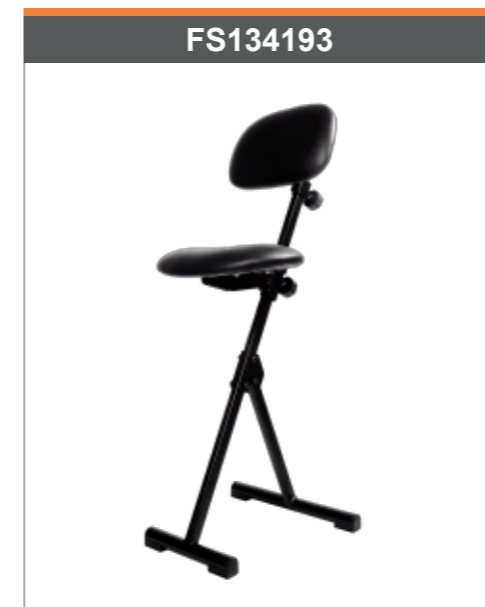

FS134193

## Product description

- Material: Vinyl/High elastic sponge / Eucalyptus wood
- Function: Back and seat up and down adjustment by manual
- Seat height adjustment range: 530-830mm (distance from seat to ground)
- Base: Φw400\*d410mm / Tubular steel frame with non-slip floor glides, chromed-plate or power coated in black
- Wheels: Fixed Ottomans, anti-skidding

Model	Seat Size (w*d)	Back Size (w*d)
FS134193	370 x 220mm	320 x 230mm

# 安装流程 instructions

**1** 气杆取下安全帽



**2** 气杆放入椅脚  
insert the gas lift to base

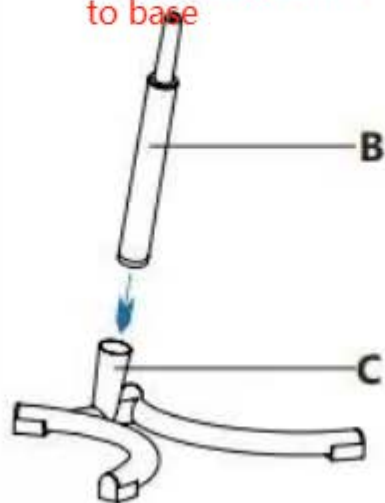

**3** 坐垫压入气杆

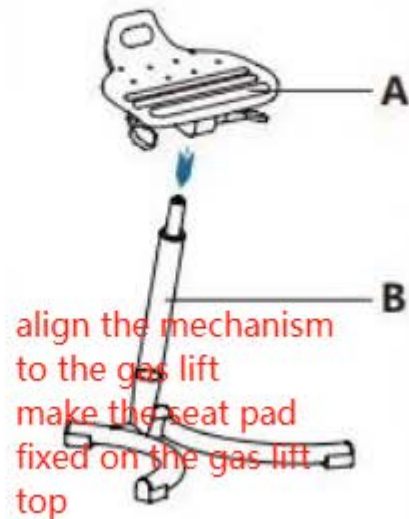

**!** 向下压实  
坐垫不脱落  
才可使用

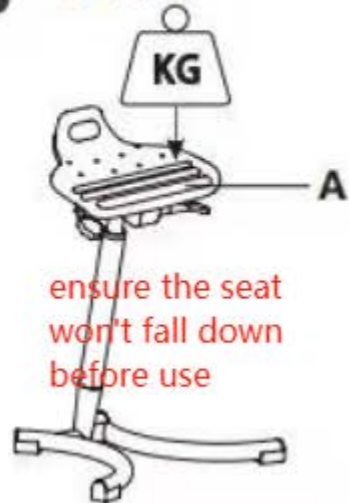

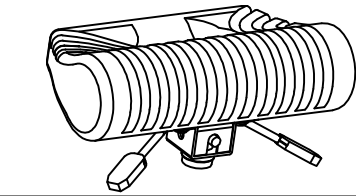
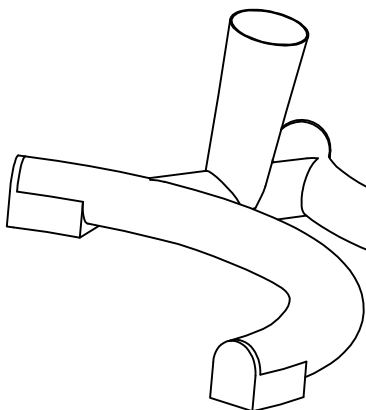
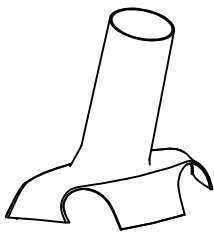
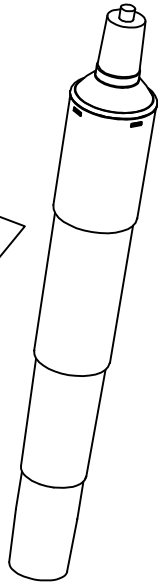
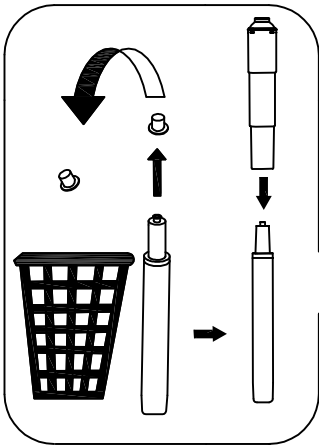
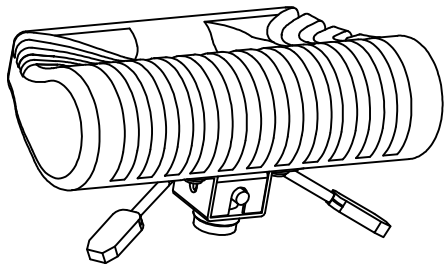

1PCS

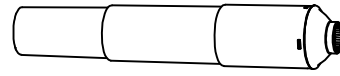

1PCS

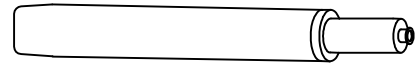

1PCS

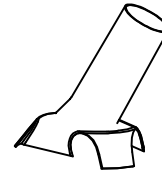

1PCS

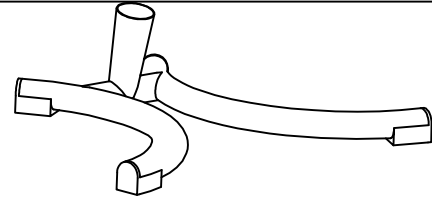

1PCS

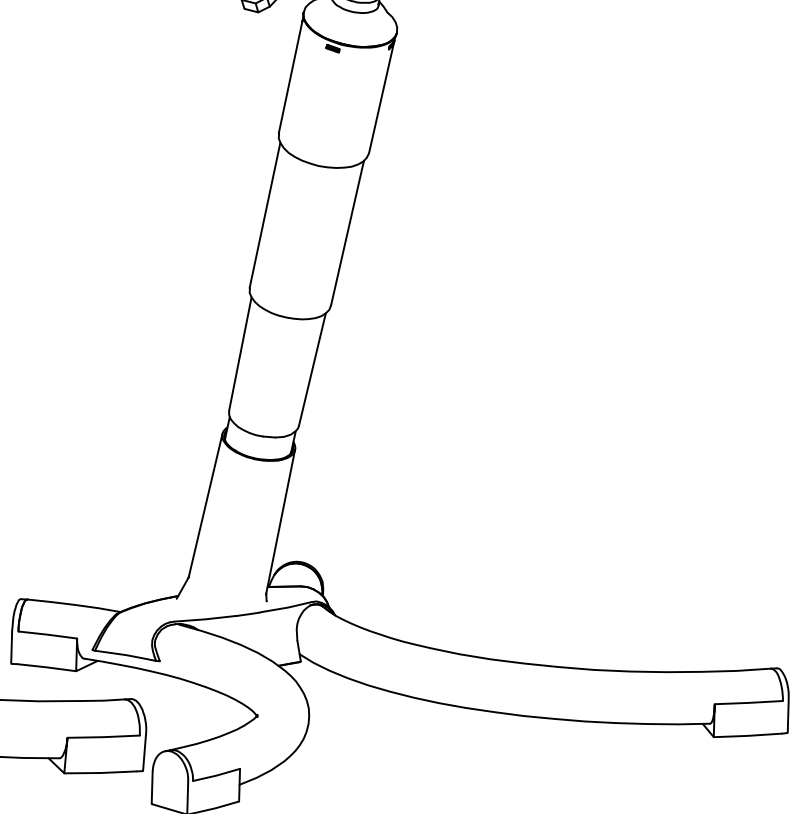
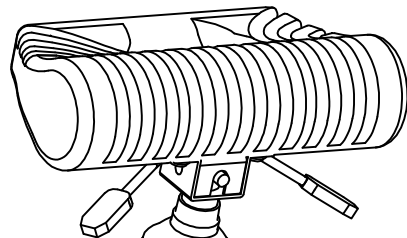



58-83cm  
height adjustment



手工测量可能有误差，请与实物为准。



# Benefits for standing chair

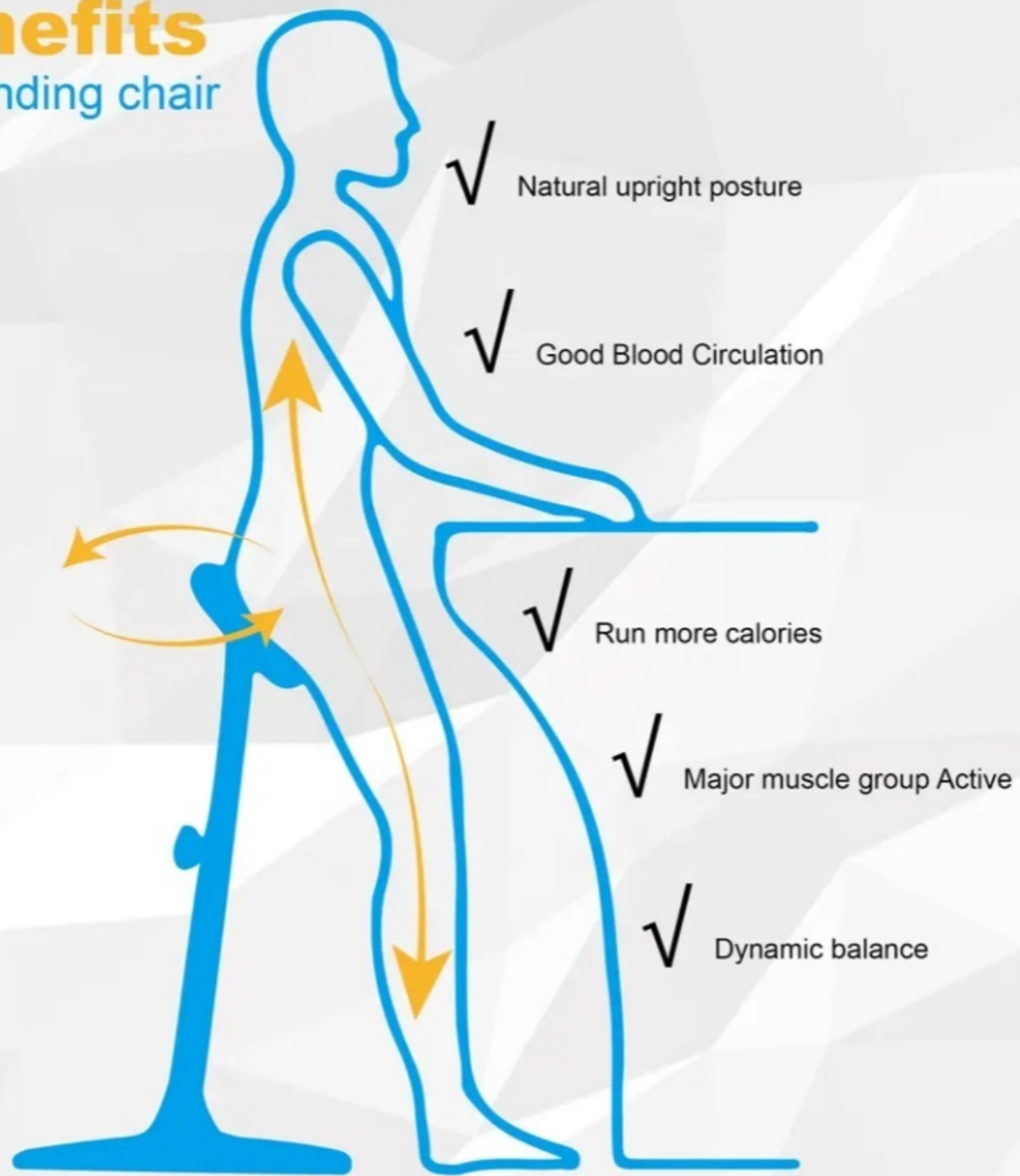

**ΣFORCE**  
力强静电





PS-518290



6118



~40cm Pls check on your measurement, if acceptable request for a sample for evaluation.

手工测量可能有误差, 请与实物为准。

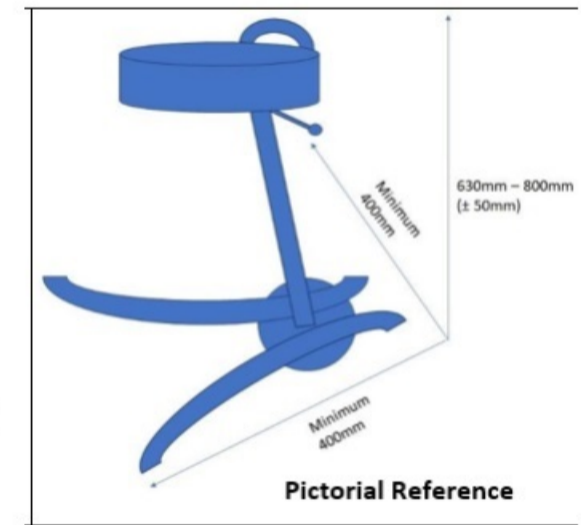

**Note:** Because we do not know if the measurement is correct over each address as correct, upon evaluation request, it need to give times for the correct item to be send down.



PU Seat for Lab

6118



PU Seat



Fiber Seat



Cushion Seat



## Comfortable Seat Cushion



Ultra soft foam Cotton



Extra Wide Seat Surface



## ESD PU back and seat, PU Foam Seat









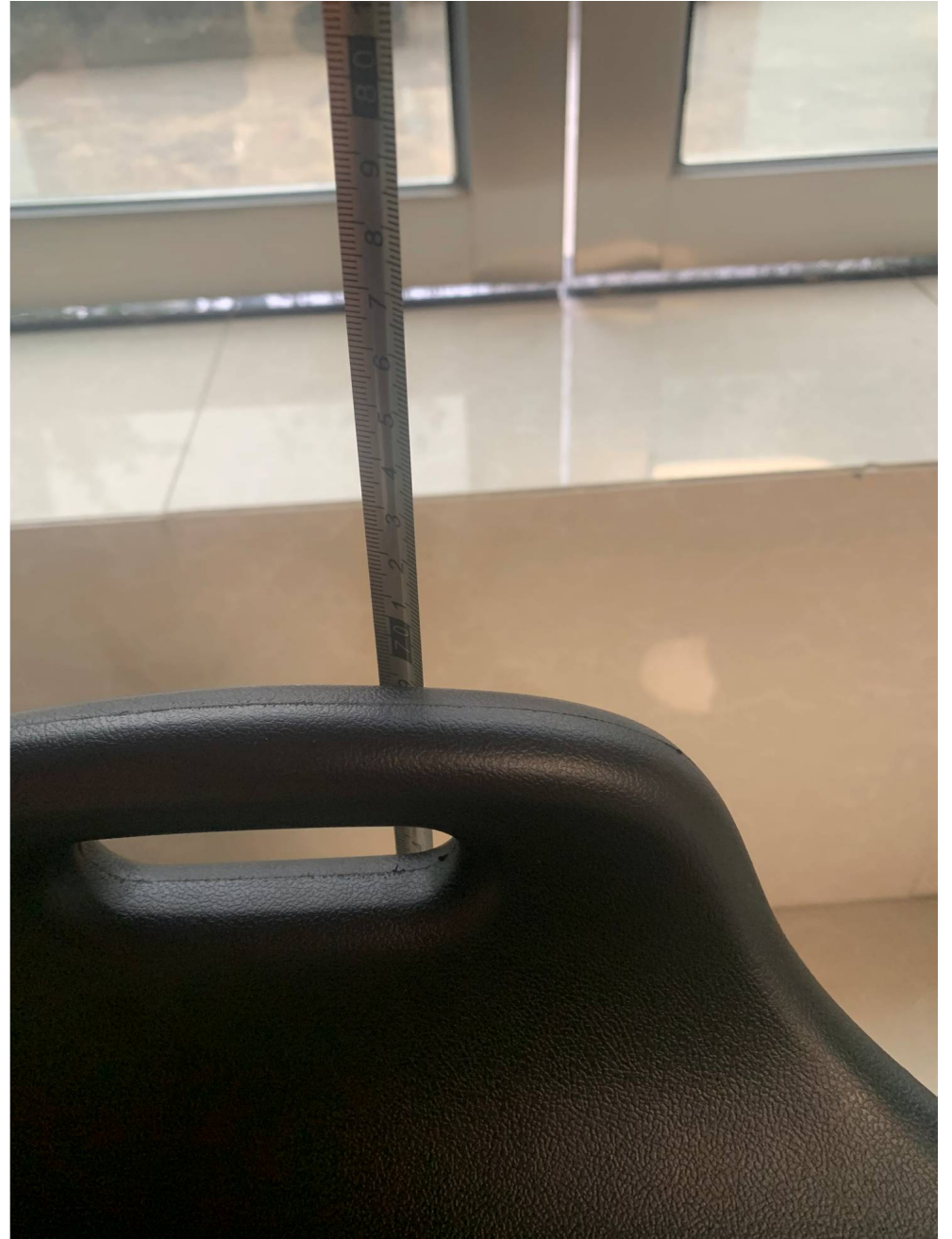









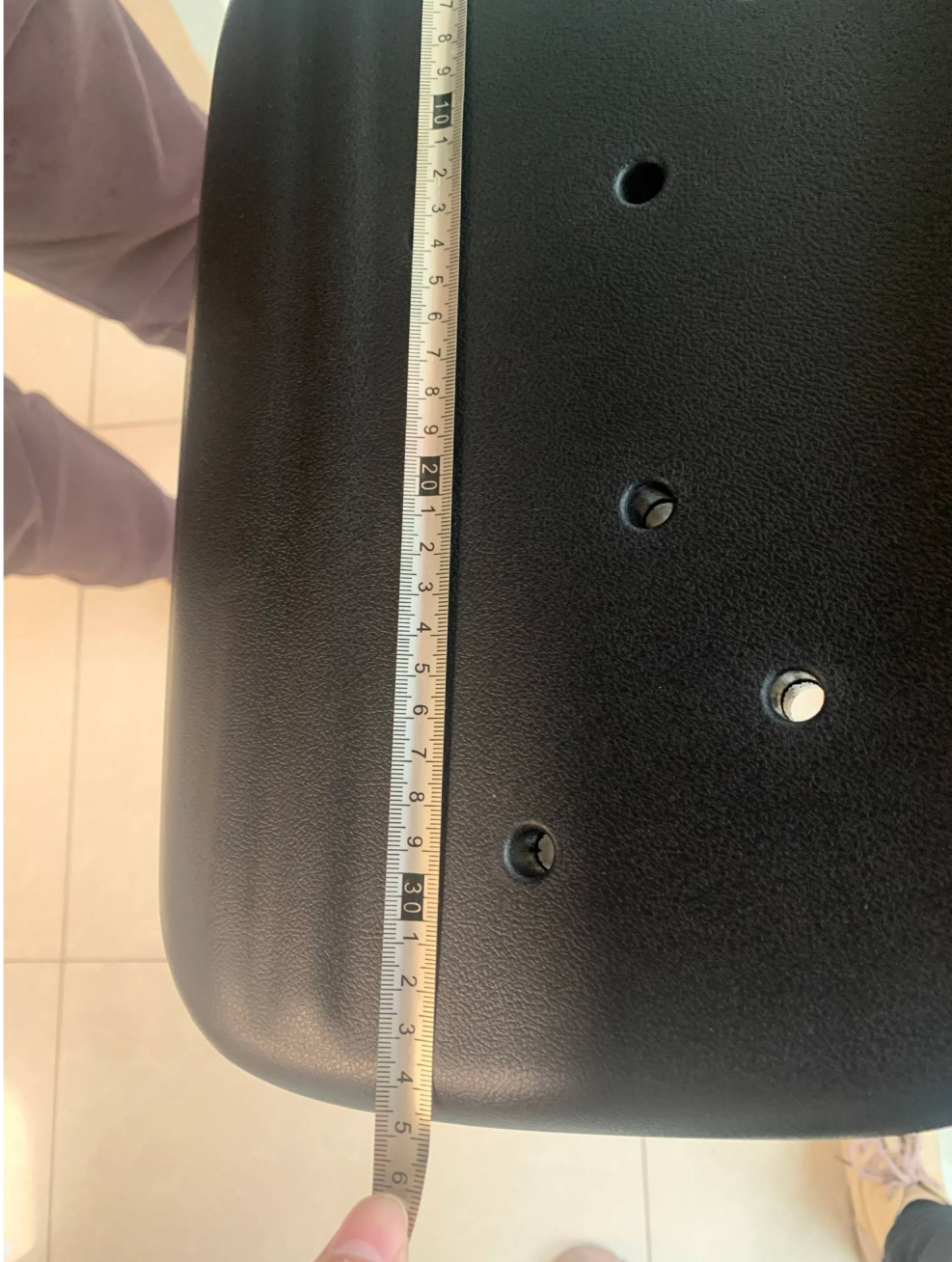









创业

创业是企业  
成功的关键  
事业成功  
创业成功  
创业成功

好想你

好想你  
好想你  
好想你  
好想你  
好想你

1916

SGS BIFMA X5.1  
APPROVED







CERTIFICATION  
INTERNATIONAL

# Certificate of Registration

This is to certify that

## SHENZHEN SIGMAFORCE INDUSTRIAL CHAIRS CO.,LTD.

Organization code: 66852777-7

Registered address: 5/F, BUILDING 13, YUSHENG INDUSTRIAL PARK, NO.467, 107 NATIONAL HIGHWAY, BAO'AN DISTRICT, SHENZHEN CITY, P.R.CHINA

Audited address: 5/F, BUILDING 13, YUSHENG INDUSTRIAL PARK, NO.467, 107 NATIONAL HIGHWAY, BAO'AN DISTRICT, SHENZHEN CITY, P.R.CHINA

Has been assessed as conforming to meet the requirements of

**ISO9001: 2008**

for the scope of activities

**Production and sales of industrial chairs.**

Certificate No: CI/133844Q

Issue Date: 23 December 2014 Valid until 22 December 2017

Subject to adherence to the agreed ongoing audit programme. ~~Subject to endorsement of certification body's audit and compliance with C-Regulators~~

Signed for and on behalf of

General Manager



063



Note: According to the certification requirements, the interval between the annual surveillance audit and the last spot audit cannot exceed twelve months.