



Shanghai ZOGEAR Industries Co.Ltd

Add: Suite 303, Building 4, NO. 406 Kang Yi Rd., Shanghai 201315, China

Tel: 0086-21-68012688

Fax: 0086-21-68012699

[Http://www.zogear.com](http://www.zogear.com)

E-mail: zogear@zogear.com

Z
O
G
E
A
R

SHANGHAI
ZOGEAR DENTAL



TRUST US

Shanghai ZOGEAR Industries Co.,Ltd, established in 2011 is a professional supplier of dental products who is engaged in developing, manufacturing and trading various dental products such as dental cotton rolls, saliva ejector, face mask, dental bibs, dental needles, sterilization pouch/reel rolls, micro applicator, diamond burs, high quality carbide bur & tungsten carbide cutters, polisher etc.

Nowadays, ZOGEAR's available certificates are CE0197, ISO13485, IOS90-01, issued by TUV,FDA and FSC.

ZOGEAR is no gorgeous appearance, but the real inner.

We always adhere to the "quality is the ZOE of enterprise, employees of the enterprise is GEAR" for the spirit of enterprise.

ZOGEAR strive to provide safe and high quality products for clients and patients. As a result, our products are enjoying a high reputation in the worldw ide such as Europe, America, South America, Asia and Australia etc.

Meanwhile, superior and speedy service works much to create remarkable customer experiences for us, which is attributed from our professional and effective work team. Our dedicated technical staffs will provide comprehensive technical support and well-trained salesman will give you satisfactory service.

Additionally, most of our products are eco-friendly because environmental protection is emphasized by all of us.

We believe that our competitive price, quick delivery, achieving customer's expectation and good after-sales service are the fundamentals of our success!

And a win-win situation is highly expected by us.

ZOGEAR is looking for reliable, longterm cooperation partners!

Welcome to ZOGEAR.

Thanks for your attention!

Gear Zhang



ISO



CONTENTS

Cotton & Sponge	P01
Personal & Barries	P05
Syringe & Denal Needle	P13
Treatment Accessories	P17
Air Water Syringe	P33
Endodontic	P35
Fiber POST	P45
Impression	P47
Laboratory	P54
Articulating Paper	P58
Orthodontic	P59
Sterilization	P61
BD Products	P63
X-Ray Accessories	P66
Dental Barries	P70
Diamond Burs & Disc & polisher	P73
Dental Rotary	P84
Cements & Liners	P94
Oral Care	P99

Cotton & Sponge



Dental Cotton Rolls

- 100% high-purity cotton
- high absorbing capacity
- Sizes and inner package can be produced according to your requirement

Ref. #	Description	Package
Bag Package		
CW001-1	1# 8mm X 38mm(0.315"X1-1/2")	1000pcs (400g)/bag,20bag/ctn
CW001-2	2# 10mm X 38mm(0.375"X1-1/2")	1000pcs (500g)/bag,20bag/ctn
CW001-3	2# 10mm X 38mm(0.375"X1-1/2")	600 pcs (300g)/bag,40bag/ctn
CW001-4	3# 12mm X 38mm(0.472"X1-1/2")	1000pcs (700g)/bag,20bag/ctn
CW001-5	4# 15mm X 38mm(0.551"X1-1/2")	345 pcs (300g)/bag,12bag/ctn
Box Package		
CW001-6	1# 8mmX38mm(0.315"X1-1/2")	2000pcs(800g)/box,12box/ctn
CW001-7	2# 10mm X 38mm(0.375"X1-1/2")	2000pcs(1000g)/box,12box/ctn
CW001-8	3# 12mmX38mm(0.472"X1-1/2")	2000pcs(1400g)/Box,12box/ctn



Cotton Rolls Dispenser

For 2#(10X38MM) dental cotton rolls



COLOR:



CW002-1

- Material: PS
- Type: drawer type
- Package: 1pc/box 42pcs/ctn



COLOR:



CW002-2

- Material: PS
- Type: press
- Package: 1pc/box 40pcs/ctn

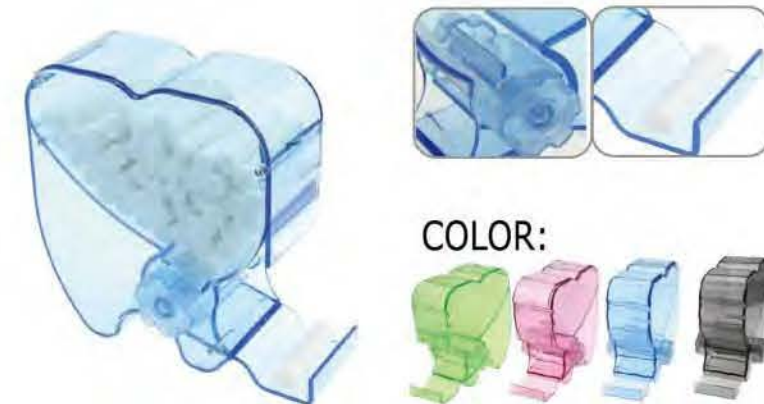

COLOR:



CW002-3

- Material: PC
- Autoclavable
- Type: Rolling
- Package: 1pc/box 30pcs/ctn



CW002-4

- Material: stainless steel
- Autoclavable
- Type: press
- Package: 1pc/box 50pcs/ctn



COLOR:

60 needles

Dental Cotton Roll Holder

CW002-6

- Material: PP, Autoclavable
- Package: 1pc/box 50box/ctn

Dental Cotton Ball Holder



25 holes

CW002-7

- Material: PP, Autoclavable
- Size: 1-7/8" x 1-7/8" x 2-1/16"
- Package: 1pc/box 100pcs/ctn

Dental Cotton Roll Holder



CW003

- Material: PP
- Color: blue
- Package: 100pcs/bag



Gauze Sponges Holder

Autoclavable



CW006

- Material: PP
- Size: 2" X 2"
- Package: 1pc/box, 100boxes/ctn



Cotton Filled Sponge

CW004

Mesh: 17 X 7

- 100% Cotton
- Size: 2" X 2" 8-ply
- Non-sterile
- Package: 200pcs/sleeve, 50sleeve/ctn



All-Gauze Sponge

CW005

- 100% Cotton
- Size: 2" X 2", 3" X 3", 4" X 4"
- Mesh: 19X9, 19x15, 25x17
- Non-sterile
- Packing: 200pcs/sleeve

Fold Edge Non Fold Edge



Non-Woven Sponge



CW007

- 100% high-purity swab
- high absorbing capacity
- Non-sterile
- Sizes and inner package can be produced according to clients' requirements



Ref.#	Description	Package
CW007-1	30g/ m ² , 2"X2" 4-ply	200 pcs/sleeve, 50sleeve/ctn
CW007-2	30g/ m ² , 3"X3" 4-ply	200 pcs/sleeve, 50sleeve/ctn
CW007-3	30g/ m ² , 4"X4" 4-ply	200 pcs/sleeve, 50sleeve/ctn
CW007-4	30g/ m ² , 4"X3" 4-ply	200 pcs/sleeve, 50sleeve/ctn
CW007-5	40g/ m ² , 2"X2" 4-ply	200 pcs/sleeve, 50sleeve/ctn
CW007-6	40g/ m ² , 3"X3" 4-ply	200 pcs/sleeve, 50sleeve/ctn
CW007-7	40g/ m ² , 4"X4" 4-ply	200 pcs/sleeve, 50sleeve/ctn
CW007-8	40g/ m ² , 4"X3" 4-ply	200 pcs/sleeve, 50sleeve/ctn

Personal Barriers

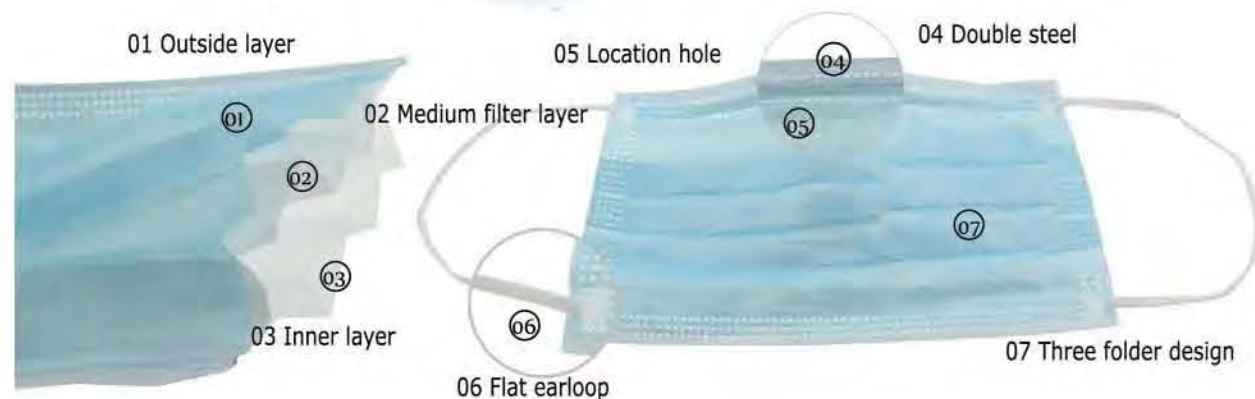

3-ply Face Mask with earloop

- Fluid resistant outer layer. (Meet ASTM F1862)
- Fluid resistant white inner layer. (By NELSON approved)
- Designed specifically for people with sensitive skin, better protection from exposing to blood and splash/spray/spatter.
- Latex-free
- Package: 50pcs/box,40box/ctn



Ref.#	Maximum Barrier	High Barrier	Moderate Barrier	Low Barrier
PB001-4	PB001-3	PB001-2	PB001-1	
Fluid Resistance	180mmHg	160mmHg	120mmHg	80mmHg
PFE	>99%	>99%	>98%	>95%
BFE	>99.9%	>99%	>98%	>95%
Delta P	<5.0 H ₂ O/cm ²	<5.0 H ₂ O/cm ²	<5.0 H ₂ O/cm ²	<4.0 H ₂ O/cm ²
Flammability	Class 1	Class 1	Class 1	Class 1



Surgical Face Mask Tie-on

PB002 (3 layer)

- Fluid Resistance 160mmHg
- PFE>99%
- BFE>99%
- Delta P <5.0 H₂O/cm²
- Flammability Class 1
- Package:50pcs/box,40box/ctn



Anti-Fog

- Earloop
- Tie-on

Pro-shield Face Mask

PB003 (3 layer)

- Fluid Resistance 160mmHg
- PFE>99%
- BFE>99%
- Delta P <5.0 H₂O/cm²
- Flammability Class 1
- Package: 50pcs/box, 20box/ctn



Top-quality Children Face Mask

(3 layer)

PB004

- Size: 12.5 X 8 cm
- Color: Bule,White,Green,Pink
- Package:50pcs/box 40boxes/ctn



Cone Mask

PB005

- BFE>98.5% @ 4.2 micron
 - 180g/square meter
 - Color: Bule,White,Pink
 - Package:50pcs/box 20boxes/ctn
- point welding staple



High-distinc Face Shield



Color:

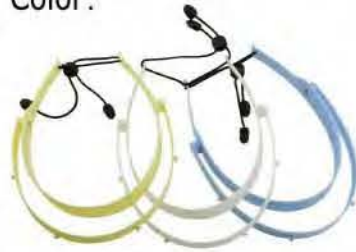

PB006A

- Optically clear, no distortion.
- Anti-fog
- Package: 1 head frame + 10 pcs shield/box



with foam

thickness:28mm

PB006B

- Optically clear, no distortion.
- Anti-fog
- Package: 1pc/bag,200bags/ctn



Color:



PB007

- Optically clear, no distortion.
- Anti-fog
- Package: 1 head frame + 10 pcs shield/box



Color:



PB008

- Optically clear, no distortion.
- Anti-fog
- Package: 1 pcs frame + 10 pcs shield/box



Eye Shield

PB009

- Protect eyes from spray and spatter
- Package: 10pcs frame + 10 pcs shield/bag



See-clear Eyewear



Color:



PB010

- Maxium UV protection
- Anti-fog, anti-static
- no-distortion
- Package: 12pcs/box



Color:



PB010F

- Rubber nose
- Maxium UV protection
- Anti-fog, anti-static,
- no-distortion
- Package: 12pcs/box



Color:



PB011

- Maxium UV protection
- Anti-fog, anti-static,
- no-distortion
- Package: 12pcs/box

Protective Light Hand Shield

PB011-4

- Maxium UV protection
- anti-static, no-distortion
- Package: 1 pcs/bag





Color:



Non Woven Bouffant cap

PB012

- Material: PP, 14g/㎡
- Latex-free
- Size: 18",21"
- Package: 100pcs/bag,20bag/ctn

regular vacuumed

Polygard Dental bib

2ply paper + 1ply poly

PB017

- 100% wooden paper, medical grade PE film.
- Paper: 17g/㎡, PE film: 13g/㎡
- Package: 125pcs/bag, 4bags/ctn

Color:



Disposable Isolation Gown

PB015

- Hand sewn ties at waist
- Material: PP, 30g/35g/㎡
- Size(cm): small 115X137
 medium 120X140
 large 130X150

- Package: 5pcs/bag, 10bags/ctn

regular vacuumed



Tie back



Velcro



Knit cuff



Elastic cuff



Lab Gown

PB016

- Material: PP, 40g/㎡
- Size(cm): small 98X118
 medium 103X123
 large 107X128
 extra large 110X134
- Package: 5pcs/bag, 10bags/ctn

regular vacuumed

Shirt collar



Knit collar



Knit cuff



Elastic cuff



Pocket



Clips for bib



PB023

- Material: Steel
- Length: 18"
- Package: 1pcs/bag



PB024

- Material: Plastic
- Length: 15-1/2"
- Package: 20pcs/bag



PB025

- Material: Plastic
- Length: 14-1/5"
- Package: 1pcs/bag



PB025A

- Material: Silicone tie, SS tip, autoclavable
- Color:
- Length: 14-1/5"
- Package: 1pcs/polybag

Shoe Cover

PB013

- Material: Non-woven
- Size: regular 16X40cm
- Color: blue
- 40g/㎡ Skid-proof
- 30g/㎡ Non Skid-proof



PB014

- 2g/3g/㎡
- Size: Regular 15X39cm
- CPE skid-proof
- PE



Bibs Holder

PB026-1

- Material: Acrylic
- Length(mm): L:180 X W:133 X D:155
- Package: 1pcs/box



PB026-2

- Material: Stainless Steel, autoclavable
- Length(mm): L:177 X W:130 X D:155
- Package: 1pcs/box





Chain-free Dental bib

2-ply paper +1-ply poly

PB018

- Size: 13" X 18" (33 X 45.5cm)
- Color: blue
- Package: 100pcs/bag, 20bags/ctn



U-Style Dental Bib

2-ply paper +1-ply poly

PB019

- Size: 16" X 18" (40.5 X 46cm)
- Package: 125pcs/bag, 4bags/ctn



Dental Apron (Tie-on)

2-ply paper +1-ply poly

PB020

- Size: 14-1/3"X24"(36.5 X 61 cm)
- pocket depth: 10cm
- Color: blue
- Package: 100pcs/bag, 5bag/ctn



Dental Bib Roll

2-ply paper +1-ply poly

PB021

- Size: 13"X18"(33X45.5cm)/sheet*220 sheets/stand
- Color: blue,green
- Package: 1 roll/plastic coated



Dental Bib Roll (Tie-on)

2-ply paper +1-ply poly

PB021-M

- Size: 58X80cm sheets,125 sheets with stand.
- Length: 100m
- Color: blue,green
- Package: 1 roll/plastic coated



Tissue Dental Chair Head Rest Cover

1-ply paper +1-ply poly

PB027

- Paper: 20g/m² PE: 20g/m²
- Size: 10"X10", 10"X13"
- Color:
- Package: 500pcs/ctn



Dental Tray Cover

PB028

- Size: 8-1/2" X 12-1/4" (21.5cm X 31cm)
- Color:
- Paper: 70g/m²
- Package: 1000pcs/ctn

Syringe & Dental Needle



Disposable Dental Needle (Sterilized)

SN001

- Size: 27G X 15/25/38mm
- 30G X 15/25/38mm

Ref. #	Description	Package
SN001-1	UK & Metric General, 27G (0.40)	100pcs/box, 50boxes/ctn
SN001-2	UK & Metric General, 30G (0.30)	100pcs/box, 50boxes/ctn



Aspirating Syringe (Brass Made)

SN002

- Material: Brass with chromium coated
- Capacity: 1.8ml



SN002-1



SN002-2

Ref. #	Description	Package
SN002-1	USA/Metric thread, triangle head	1pcs/box
SN002-2	USA/Metric thread, hook head	1pcs/box

12CC Utility Syringes

SN003

- Designed for surgical site and post-surgical home irrigation, similar to Monoject #412 syringe
- Can be used with silicone and rubber-based impression materials
- Package: 50pcs/bag, 24bag/ctn

Curved Straight



Luer Lock

Cap

Luer Slip

Luer Lock & Luer Slip Irrigation Syringe

Ref. #	Description	Package
SN004-1	1.2cc	100pcs/bag, 50bags/ctn
SN004-2	3cc	100pcs/bag, 38bags/ctn
SN004-3	5cc	100pcs/bag, 30bags/ctn
SN004-4	10cc	100pcs/bag, 15bags/ctn
SN004-5	12cc	100pcs/bag, 15bags/ctn





SN004-6

- 1.2cc injection syringe
- autoclavable
- Package: 1pcs/bag , 200pcs /ctn



Pre-Bent needle tips



straight available

Ref. #	Description	Package
SN005-1	18G,liner	100pcs/bag,600bag/ctn
SN005-2	20G,flow-sealant	100pcs/bag,600bag/ctn
SN005-3	21G	100pcs/bag,600bag/ctn
SN005-4	22G	100pcs/bag,600bag/ctn
SN005-5	23G	100pcs/bag,600bag/ctn
SN005-6	24G	100pcs/bag,600bag/ctn
SN005-7	25G	100pcs/bag,600bag/ctn
SN005-8	Full plastic,straight,20G	100pcs/bag,600bag/ctn
SN005-9	Full plastic,straight,21G	100pcs/bag,600bag/ctn
SN005-10	Full pastic,curved,20G	100pcs/bag,600bag/ctn
SN005-11	Full plastic,curved,21G	100pcs/bag,600bag/ctn



OptiProbe Needle Tips

- Closed-end cannula and a side window dispersal point.
- The Optiprobe irrigation probe offers a unique design for unmatched effectiveness, patient comfort, and safety in irrigating root canals and periodontal pockets.

Ref. #	Description	Package
SN005-12	23G Blue	100pcs/bag
SN005-13	27G Grey	100pcs/bag
SN005-14	30G Yellow	100pcs/bag

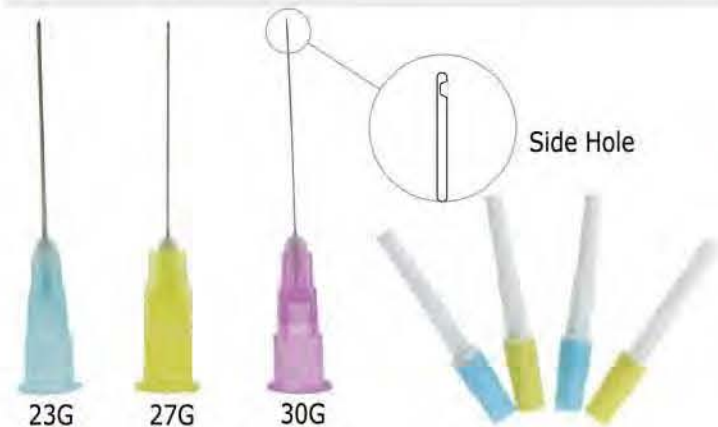

Irrigation Needle Tips

- Bendable needle 1" monoject style (notched) needle tips,color coded for easy identification of 23,27,or 30 G.

Ref. #	Description	Package
SN005-15	23G Blue	100pcs/bag
SN005-16	27G Yellow	100pcs/bag
SN005-17	30G Purple	100pcs/bag



Pre-Bent Micro-Aspirator Tips

SN006

- Special design with flexible 20mm length follows curved canals all the way to the apex
- Iner Diameter: 0.18-0.25mm, Outer diameter 0.4-0.5mm
- Luer-lock ends

Irrigation system kit

SN010

- EO Sterilization
- Package: 10sets/box, 12boxes/ctn



SN010-1



SN010-2



SN010-3



SN010-4



SN010-5



SN010-6



SN010-7

SN010-1 Irrigation system kit: is compatible with KAVO INTRASURG300/300 PLUS/500/1000/1000 AIR

SN010-2 Irrigation system kit: is compatible with BIEN AIR Hersel/Chiropro/Chiropro 980,PIEZON MASTER Surgery, Piezosurgery II,Surgisonic I,USB Ultrasonic bone surgery,Surgybone/Acrobone/Easybone Silfradent

SN010-3 Irrigation system kit: is compatible with W&H Implanted/NOBELBIOCARE 80/osseo set 100/200/osseocare. FRIADENT FRIOS unit S/Si,3i surgical unit. STRAUMANN ZIMMER DENTAL,Lifecore center pulse,Innova Corp

SN010-4 Irrigation system kit: is compatible with ANTHOGRYR Implanteo

SN010-5 Irrigation system kit: is compatible with W&H Elcomed200/100/9925

SN010-6 Irrigation system kit: is compatible with NOUVAG 3000/7000/MD10/MD20. STRAUMANN SM12

SN010-7 Irrigation system kit: is compatible with NSK Surgic XT Plus,Osseocision,VarioSurg,Implantor Neo,Aseptico Aeu 7000,Aseptico Aeu 6000

Treatment Accessories



Comfort Saliva Ejector

- Smooth tip, non-removable
- Alloy wire (brass coated)
- Package: 100pcs/bag, 10bags/ctn

Ref. #	Description
TA001-1	Clear tube with blue tip
TA001-2	Clear tube with clear tip
TA001-3	White tube with white tip
TA001-4	Green tube with clear tip
TA001-5	Blue tube with clear tip



Free Form Saliva Ejector

TA002

- Unique coil design is adjustable for maximum patient comfort
- Package: 100pcs/bag, 25bags/ctn.

Comfort Evacuator Ejector

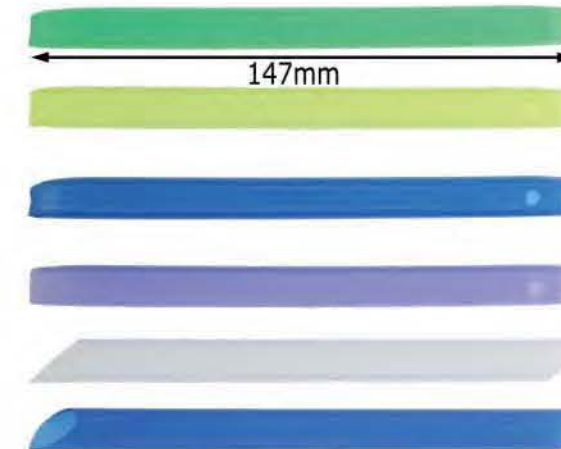

Ref. #	Description	Package
TA003-1	Vented	100pcs/bag, 10bags/ctn
TA003-2	non-vented	10bags/ctn



Ref. #	Description	Package
TA003-3	Slotted	100pcs/bag, 10bags/ctn

Surgical Aspirator tip

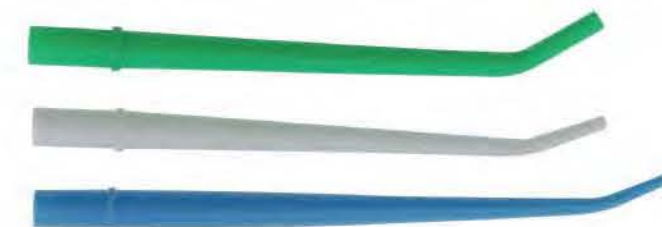

- 30° angles, fits high-volume used with evacuation systems.

Ref. #	Description	Package
TA004-1	Green 1/4"	25pcs/bag, 50bags/ctn
TA004-2	white 1/8"	25pcs/bag, 50bags/ctn
TA004-3	blue 1/16"	25pcs/bag, 50bags/ctn



TA007-2

EO Sterilization

- Material: ABS with 30° angle
- Diameter: 1/8"
- Package: 20pcs+1 pair adaptor/box

Evacuator suction tip sleeve



- Material: Silicone
- Autoclavable 135°C

Ref.#	Description	Package
TA006-9	Dark blue	10pcs/bag
TA006-10	Light blue	10pcs/bag

Suction tip



Ref.#	Description	Package
TA008-1L	Disposable	50pcs/bag,
TA008-1S	Disposable	20bag/ctn

Adaptor

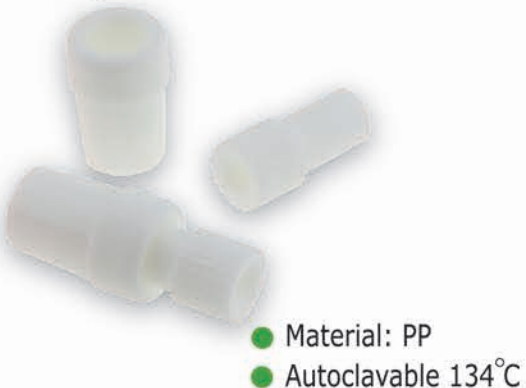

- Material: PP
- Autoclavable 134°C

Ref.#	Description	Package
TA007-1L	L:0.433" (1.1cm)	100pcs/bag
TA007-SL	S:0.256" (0.65cm)	100pcs/bag

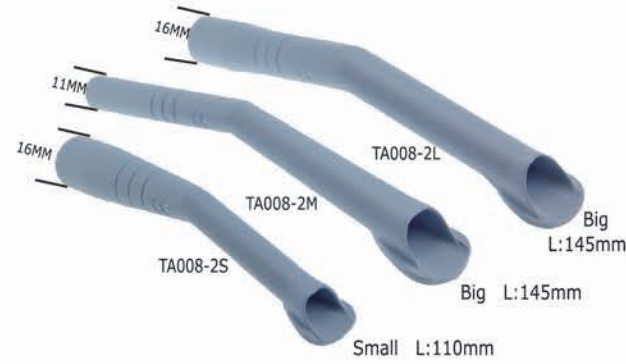

Ref.#	Description	Package
TA008-2L	Autoclave	50pcs/bag
TA008-2M	Autoclave	50pcs/bag
TA008-2S	Autoclave	50pcs/bag

Mouth Mirror With Suction Hole

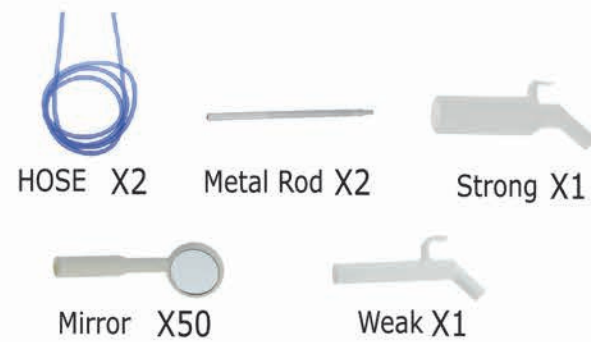
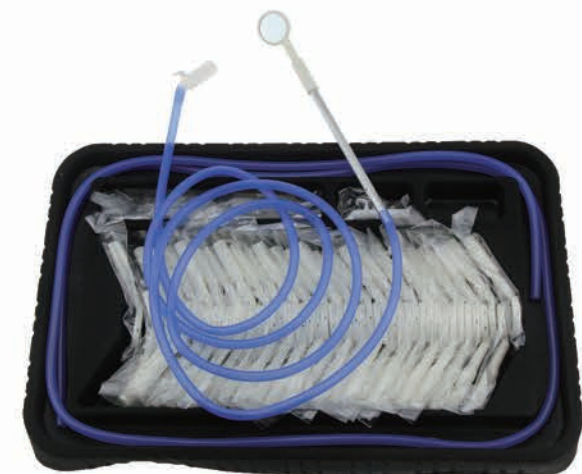

Ref.#	Description	Package
TA005	Lens:disposable Metal rod:Autoclave Hose:Autoclave Strong/weak:Autoclave	1set/box

Disposable Traps

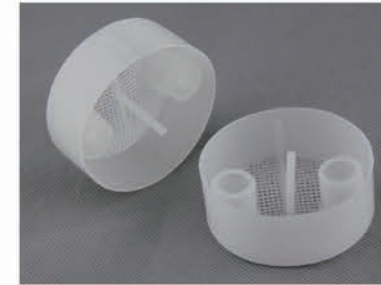

- TA006-1**
- Fits A-dec models with black plastic canister
 - Size:2-1/8"
 - 144pcs/bag,8bags/ctn



- TA006-2**
- Fits A-dec models with metal canister
 - Size:2-1/4"
 - 144pcs/bag,8bags/ctn



- TA006-3**
- Fits Ampco,Belmont,Biotec, Chayes,Dabi-Atlante, Dansereau,DCI,Den-Tal-EZ, Denttech,Forest,Knight, etc
 - Size:1-7/8"
 - 144pcs/bag,8bags/ctn

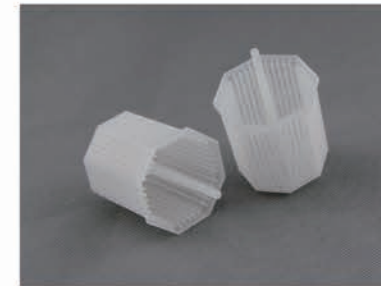

- TA006-4**
- Fits DCI/Belmont Reality
 - Size:1-1/2"
 - 144pcs/bag,8bags/ctn



- TA006-5**
- Fits most Cuspidor Bowls including:A-Dec,Ampco, Belmont,Dabi-Atlante,etc.
 - Size:Cuspidor: 2-1/2" basket:1-1/4"
 - 144pcs/bag,8bags/ctn



- TA006-6**
- Fits Siemens,Planmeca,and many cuspidors with small diameter openings
 - Size:Cuspidor:2-3/4" basket:1"
 - 144pcs/bag,8bags/ctn



- TA006-7**
- Fits as a "cap" on all standard High Volume Evacuator Trap
 - 144pcs/bag,60bags/ctn

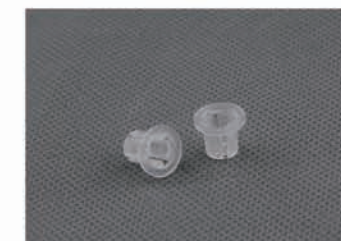

- TA006-8**
- Fits all Saliva Ejector Trap
 - 144pcs/bag,120bags/ctn



- TA009-5** **TA009-6**
- Suit For 5OZ/7OZ cups
- TA009-5**
For Being mounted on dental chair unit
- TA009-6**
With Magnetic Design

Plastic Cup



Ref.#	Description	Package
TA009-1	5 OZ (148ml)	50pcs/bag 20bags/ctn

Paper Cup



Ref.#	Description	Package
TA009-2	5 OZ (148ml)	100pcs/bag
TA009-3	7 OZ (207ml)	30bags/ctn

Plastic Rubber Dam Frame



TA014-1

TA014-2

TA014

- Material: PP, Autoclavable
- TA014-1: 10pcs/bag, 40bags/ctn
- TA014-2: 1pc/bag, 200bags/ctn

Hand-free Cheek Retractor (Double Span)

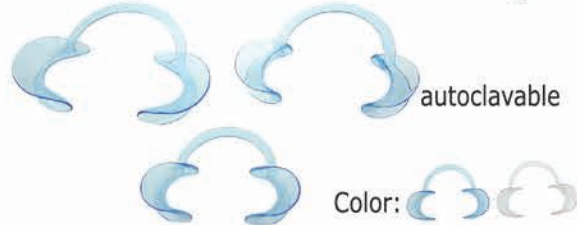

Ref.#	Description	Package
TA010-1B	Big	20pcs/bag 50bags/ctn
TA010-1M	Medium	
TA010-1S	Small	

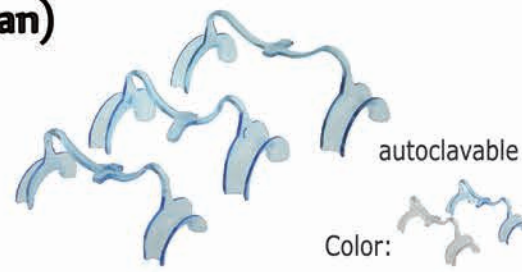

Ref.#	Description	Package
TA010-2B	Big	20pcs/bag 50bags/ctn
TA010-2M	Medium	
TA010-2S	Small	

O Style Cheek Retractors



Ref.#	Description	Package
TA011	Regular	10pcs/bag



Ref.#	Description	Package
TA012-1B	single head, Adult	20pcs/bag
TA012-1S	single head, child	
TA012-2B	Double head, Adult	50bags/ctn
TA012-2S	Double head, child	

Rubber Mouth Support



Ref.#	Description	Package
TA013-1	Big(green)	50pcs/bag 20bags/ctn
TA013-2	Medium(blue)	
TA013-3	Small(purple)	

Tongue Separate Kit



Ref.#	Description	Package
TA013-4	Big(purple)	12sets/boxes 27boxes/ctn
TA013-5	Medium(green)	
TA013-6	Small(yellow)	

100% Natural Rubber Dam Cheek Retractor



picture 1



picture 2



picture 3

TA015

- Natural curvature open mouth, not only to ensure open degree, patient won't feel tired in long time treatment.
- Suggestion: Wet it before use for placement.
- EO sterilization
- Package: 60pcs/box, 12box/ctn
- Size: Medium: 87X87mm
Small: 73X73mm



picture 1



picture 2



picture 3



picture 4

TA016

- Natural rubber barrier is a curvature appearance of the rubber gate, can in the surgery patients easily to open your mouth, convenient operation. Improve the road and visibility, save time to treatment, improve patients' comfortable levels.
- EO sterilization
- Package: 60pcs/box, 12box/ctn
- Size: Medium: 87X87mm
Small: 73X73mm

Mouth Mirror & Handle



Stainless steel

Ref.#	Description	Package
TA017-1	4# Anti-heat plain	12pcs/box, 100boxes/ctn
TA017-2	4# Anti-heat magnifying	12pcs/box, 100boxes/ctn
TA017-3	5# Anti-heat plain	12pcs/box, 100boxes/ctn
TA017-4	5# Anti-heat magnifying	12pcs/box, 100boxes/ctn
TA017-5	Round handle (SS)	10pcs/box, 50boxes/ctn
TA017-6	Six Corner handle (SS)	10pcs/box, 50boxes/ctn

Mouth Mirror

Disposable



TA018

- Disposable, used for oral examination, ABS handle
- Lens: Glass/PC
- EO sterilization
- Package: 1pcs/bag, 300bags/box, 6boxes/ctn

Mouth Probe

Disposable

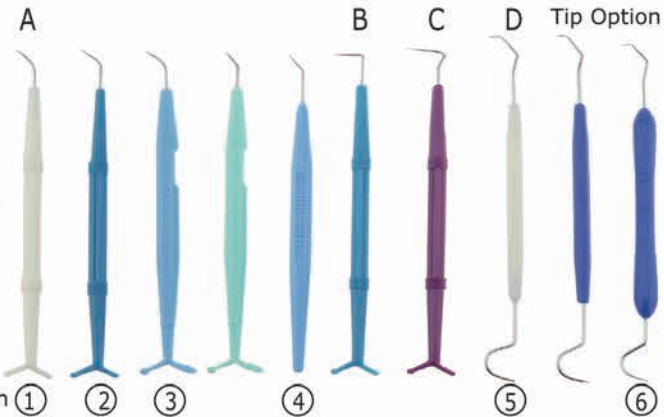

TA019

- Disposable, used for oral examination, ABS handle, SS tip
- Single sterilization pouch
- Single head/Double head
- Package: 1pcs/bag, 300bags/bag, 6box/ctn

Mouth Probe with scale

Disposable

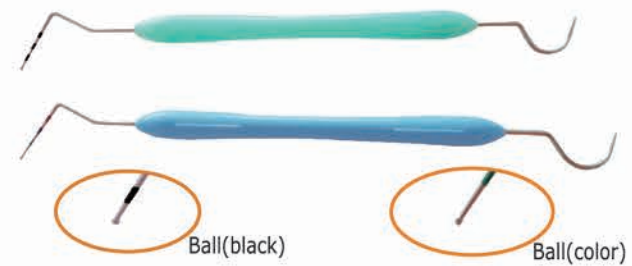
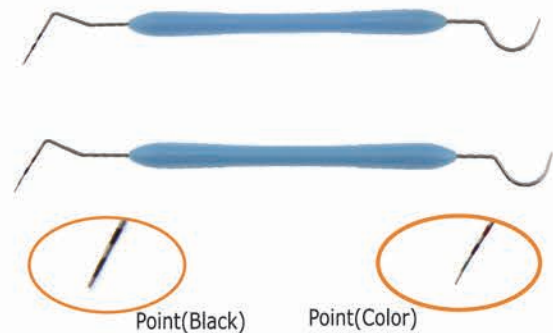

Ref. #	Description	Package
TA019-3	Double head, point with scale	300pcs/box 6box/ctn

Tweezer

Disposable

TA020-1

- SS tip, ABS handle
- Package: 1pcs/bag, 300bags/box, 6box/ctn



Tweezer

Disposable



TA020-2

- Steel with zinc coated
- Package: 100pcs/bag.

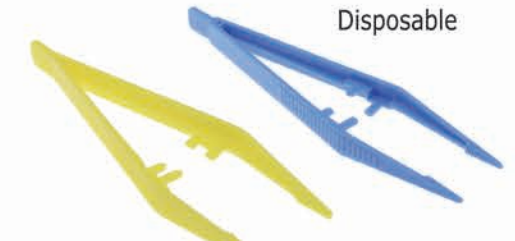

TA020-3

- Full plastic, ABS material
- Package: 100pcs/bag.



TA021-1

- 2pcs/set (mirror, probe)
- material: ABS
- Package: 200kits/box, 6box/ctn

DIY Mouth Mirror from TA018
Mouth Probe from TA019



TA021-2

- 3pcs/set (mirror, probe, tweezers)
- material: ABS
- Package: 100kits/box, 6box/ctn

DIY Mouth Mirror from TA018
Mouth Probe from TA019
Tweezer from TA020



TA021-3

- 5pcs/set (mirror, probe, tweezers, bibs, tray)
- material: ABS
- Package: 200kits/ctn

DIY Mouth Mirror from TA018
Mouth Probe from TA019
Tweezer from TA020
Bibs from PB017/PB018

Complete kit of implantology wear

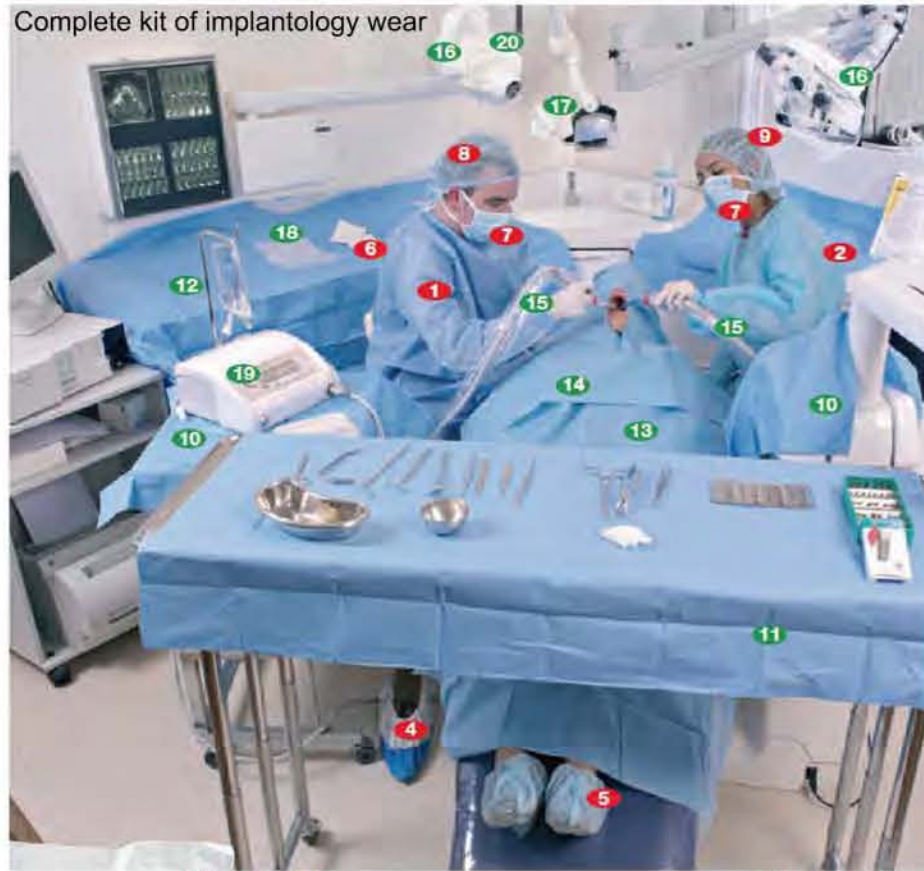

- TA021-4A**
- Each Kit contains:
- 1 surgical gown, SMS blue, 55g/㎡, impermeable with knit cuffs
 - 1 assistant gown, polypropylene, 50g/㎡, impermeable with cotton cuffs
 - 1 pair of patient overshoes
 - 2 hand towels
 - 3 tie on masks
 - 2 surgical hats
 - 3 bouffant caps

- TA021-4B**
- Each Kit contains:
- 2 drapes 75 x 75 cm
 - 1 instrument (bridge) table cover 90 x 120cm, 43g/㎡, impermeable
 - 1 instrument table cover 100 x 180 cm, 43g/㎡, impermeable for work plan.
 - 1 non woven "U" drape with adhesive 100 x 150 cm
 - 1 non woven surgical drape with adhesive 70 x 100 cm
 - 3 plastic sheets 8 x 120 cm with adhesive
 - 2 adhesive films 5 x 80 cm
 - 2 elastic wrist protectors
 - 1 plastic bag 50 x 80 cm
 - 1 protection for panel control with adhesive
 - 1 elastic cap radio cover

Dental Surgical kit



- TA021-4C**
- Contains:
- Patient's drape 75X90cm
 - Transparent hose cover 10X200cm
 - Transparent hose cover 10X60cm
 - Reflector drape 15X15cm
 - Table drape DL 50X75cm
 - Bundle cover 50X50cm



- TA021-4D**
- Contains:
- 3 drapes 60*80cm
 - 2 instrument (bridge) table cover 120*120cm, 50g/㎡, impermeable
 - 1 non-woven fenestrated drape 160*170cm
 - 1 suture bag 30*16cm
 - 4 double side tape 2*20cm
 - 2 surgical hats
 - 2 tie-on face masks
 - 1 surgical gown, SMS blue, 50g/㎡, impermeable with cotton cuffs
 - 2 plastic sheets 8*120cm with adhesive

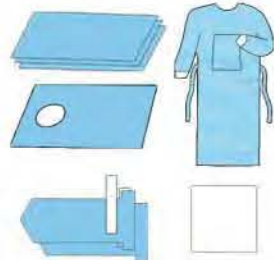

- TA021-4E**
- Contains:
- 2 Surgical Gown Standard-Large with in overwrap
 - 2 Absorbent Towel
 - 1 Drape (175*150 cm), circular fenestration (7) with adhesive (10*10cm)
 - 2 sleeve cover (7.5*120cm)
 - 1 Back table cover (80*100cm)

Prophy Cup



100pcs/box

Prophy Angle Plus



144pcs/box

Prophy Paste Ring

TA023-1F

- Fit for all 2g prophy paste cups
- Package: 200pcs/bag

Prophy Brush



100pcs/bag

Prophylaxis Powder



TA025-1

- Mesh 200, Mint-taste
- 40g/bag



TA025-2

- Mesh: 180-200, 130g/bottle
- Package: 20bottle/box, 6box/ctn



Micro Applicator

Disposable



Regular:2mm



Fine:1.5mm



Superfine:1mm



Extra Fine



TA026A

- Non-absorbent
- Non-linting fibers
- Bendable neck
- Different color for different solutions
- Package:100pcs/bottle, 4bottle/box,60box/ctn

Ref.#	Size	Color
TA026A-1	Regular	Green,Purple,Orange,Blue
TA026A-2	Fine	Yellow,Mauve
TA026A-3	Super fine	White
TA026A-4	Extra fine	Black



Brush Applicator

TA026B

- Chemical resistant fibers hold up to the harshest dental materials
- Bends close to tip for improved control and easily reaching
- Usage: Whitening,Fluoride,Etchants,Bonding Agents,Sealants,Desensitizers,Adhesives / Resins

Ref.#	Description	Package
TA026B-1	Single head brush	100pcs/bundle 128bundles/ctn
TA026B-2	Double-head brush	100pcs/bag 4bags/box 32boxes/ctn

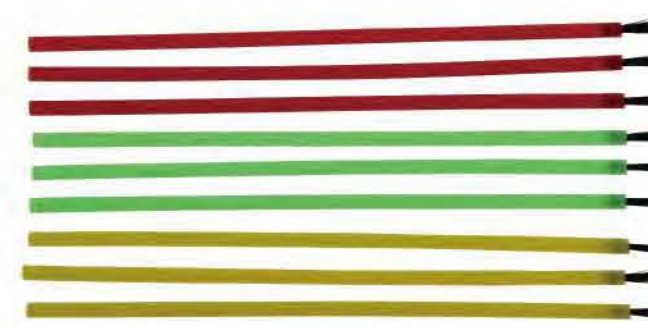

Bendable Brush Applicators

TA026C

- Chemical resistant fibers hold up to the harshest dental materials
- Flexible and bendable to reach all areas
- Package:144pcs/bag,100bags/case

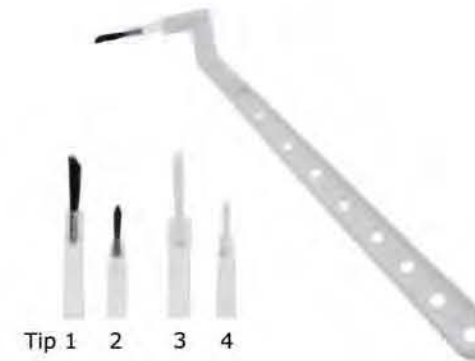

Composite Brush

TA026D

- Made of rigid plastic to withstand repeated autoclaving (up to 120°C)
- Tip can be replaced,save cost

Ref.#	Description	Package
TA026D-1	Handle+Tip	100pcs/bag,40bag/case
TA026D-2	Tip(black,white)	100pcs/bag



Valustick Sticky Applicators

TA027

- bends into any angle for placement of Venners, Inlays,Onlays,Crowns etc
- Strong adhesive , Disposable
- Package: 10pcs/plate,10plate/box

Fixing Plastic Wedges



TA028

- Anatomically designed

Ref.#	Description	Package
TA028A-1	L(16X2.6X2.2mm)	100pcs/box
TA028A-2	M(14X2.2X2mm)	
TA028A-3	S(12X1.9X1.9mm)	
TA028A-4	XS(10X1.6X1.5mm)	

Fixing Plastic Wedges with hole



TA028B

- Anatomically designed

Ref.#	Description	Package
TA028B-1	L(17.8X2.8mm)	100pcs/box
TA028B-2	M(17.8X2.45mm)	
TA028B-3	S(17.8X2.1mm)	
TA028B-4	XS(17.8X1.7mm)	



Fixing Wooden Wedges

TA029

- Eco-friendly wooden wedges, round tips protect the gingiva from damage, smooth round edge, square stern.
- Size: L:19.2X2.9X2.2mm M:18.2X2.6X1.8mm S:17.2X2.3X1.4mm XS:17.2X1.9X1.3mm
- Package: 100pcs/bottle, 18bottle/box, 30box/ctn

Plastic Wedges with handle

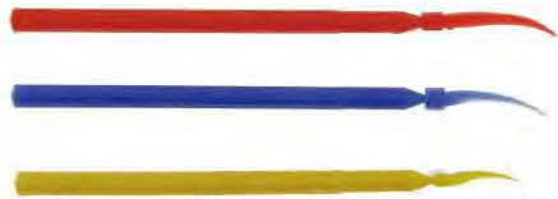

Ref.	Description	Package
TA030-1	L:81X2.7mm orange	100pcs/bag
TA030-2	M:79X2.6mm blue	
TA030-3	S:77X2.1mm yellow	

Amalgam Carrier



TA031-1

- Material: Plastic
- Package: 100pcs/bag, 20bag/ctn

Unit Dose Composite Dispensing Gun



TA031-2

- Dispensing gun for unit dose composite capsules.
- Package: 1pcs/bag, 160bags/ctn

Capsule



TA031-3

- Package: 100pcs/bag, 100bags/ctn

Denture Box



TA033-1L

- Material: PP
- Color: yellow, blue, green, white, pink, light blue
- Size: L:82mm X 85mm X 45mm,
- Package: 12pcs/box, 24box/ctn



TA033-1S

- Material: PP
- Color: yellow, blue, green, white, pink
- S:82mm X 85mm X 28mm
- Package: 12pcs/box, 30box/ctn

Denture Box



TA033-2L

- Material: PP
- L:95mm X 73mm X 56mm
- Package: 12pcs/box, 24boxes/ctn



TA033-2S

- Material: PP
- L:95mm X 74mm X 39mm
- Package: 12pcs/box, 30 boxes/ctn



TA033-3

- Material: PP
- L:99mm X 77mm X 59mm
- Package: 12pcs/box, 16boxes/ctn



TA033-4

- Material: PP
- L:100mm X 83.5mm X 40mm
- Package: 12pcs/box, 16boxes/ctn



TA033-5

- Material: PP
- Size:80mm X 66mm X 27mm
- Package: 12pcs/box, 30boxes/ctn



TA033-6

- Material: PP
- Size:110mm*83mm*55mm
- Package: 12pcs/box, 30boxes/ctn

Denture Bath Box



TA034

- Material: PP
- Size:92mm X 85mm X 57mm
- Package: 12pcs/box, 16boxes/ctn

Denture Clean tool Container



TA035

- Material: PP
- Size: 86mm X 78mm X 78mm
- Package: 4pcs/box, 30boxes/ctn



Denture Deliver Box



TA036

- Material: PP
- Size: 55mm X 50.2mm X 25mm
- Package: 12pcs/box, 32box/ctn

Denture Box with mirror



TA037

- Material: ABS+PC
- L: 82.5mm X 74mm X 29mm
- Package: 12pcs/box, 30 box/ctn

Denture Box with mirror



TA038

- Material: ABS+PC
- L: 115.8mm X 92.8mm X 37.6mm
- Package: 12pcs/box, 30 box/ctn

Primary teeth box



TA039

- Material: PP
- Size: 22X22mm
- Package: 10pcs/bag



Germicide tray

TA040

- Disinfecting / Sterilizing Tray System is an integral part of The Scientific System for Better Aseptic Technique.
- Size: 10 3/8" W x 3 1/4" H x 4" D
- Package: 1pcs/box, 40box/ctn

Image Reflector

Stainless Steel

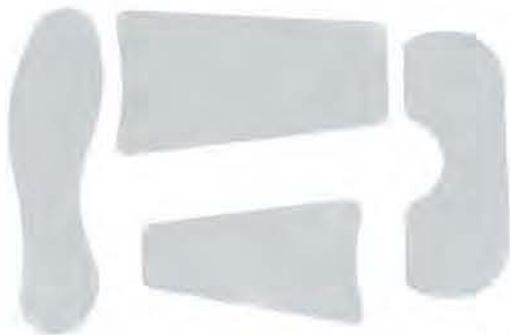

TA041-1

- Offer the finest possible color and image transfer. Maximum reflective quality, smooth edge.
- 4 different shape, autoclavable
- Type: double side
- Package: 1kit/box



Image Reflector

Glass



TA041-2

- Offer the finest possible color and image transfer. Maximum reflective quality, smooth edge.
- 4 different shape, autoclavable
- Type: single side
- Package: 1kit/box

Ivory Matrix Retainers



TA042

- The most famous Ivory - model and practical to use for matrix bands to separate teeth on the lower jaw.
- Suitable Matrix bands are: TA043
- Package: 1pcs/bag

Ivory Matrix Bands



TA043

- Material: medical grade stainless steel
- Package: 20pcs/bag

Ref.TA043-1 Bicuspid Narrow
 Ref.TA043-2 Bicuspid Medium
 Ref.TA043-3 Bicuspid Wide

Thin/Tofflemire/Ivory Matrix Bands

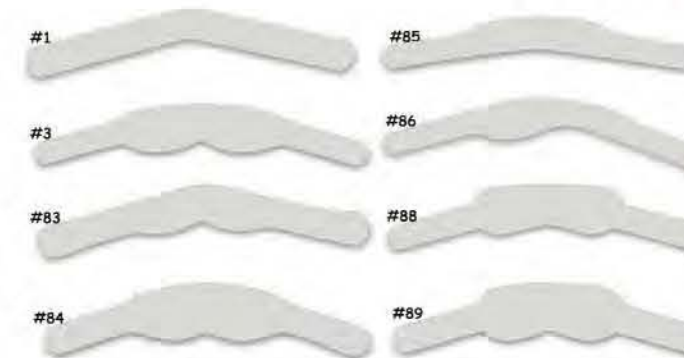

TA044

- These are the best—in quality, design and - function. Made of the highest quality medical grade stainless steel.
- Thin, regular or dead soft.
- Package: 12pcs/bag

#83-Molar Narrow #84-Molar Medium
 #85-Molar Wide #86-Molar X-Narrow
 #88-Bicuspid Medium #89-Bicuspid Wide

Air Water Syringe Tip

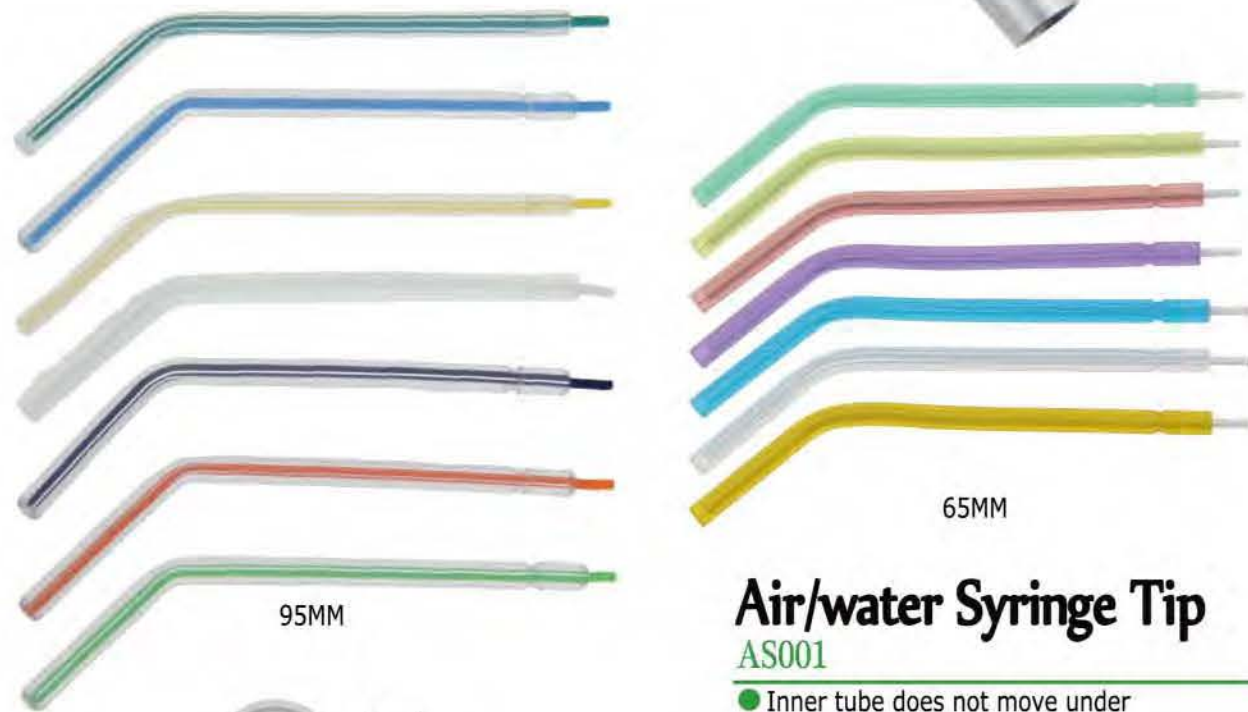

95MM

65MM

Air/water Syringe Tip

AS001

- Inner tube does not move under pressure
- Designed for snug locking fit
- Don't need any conversion with most metal tips with no conversion
- Quad air-core design with separate air and water channels



Quad Air-Channel Design

Ref.#	Description	Package
AS001-1L	Clear tube with color core	100pcs/bag, 100bags/ctn
AS001-1S	Color tube with clear core	

Air Water Syringe Tip



For American Type Syringe

For European Type Syringe

Ref.#	Description	Package
AS001-2	White tube, SS inner core	100pcs/bag
AS001-3	White tube without core	100pcs/bag
AS001-4L	Clear Transparent	250pcs/bag
AS001-4S	Clear transparent	250pcs/bag



Air/water Syringe tip cover

AS002

- Cover Air water syringe tips from Andent Dental, prevent exposure and contamination from dust.
- Package: 250pcs/bag, 40bag/ctn



Air/water Syringe tip

AS003

- Package: 100pcs/bag, 18bag/ctn



Air/water Syringe tip fitting

AS004

- Material: aluminium alloy
- Size: big/small

Endodontic



Hand Use, Stainless Steel

Package: 6pcs/box



H File 21MM

SIZE	08	10	15	20	25	30	35	40
Ref. #	SH0821	SH1021	SH1521	SH2021	SH2521	SH3021	SH3521	SH4021
SIZE	45	50	55	60	70	80	15-40	45-80
Ref. #	SH4521	SH5021	SH5521	SH6021	SH7021	SH8021	SH154021	SH458021

25MM

SIZE	08	10	15	20	25	30	35	40
Ref. #	SH0825	SH1025	SH1525	SH2025	SH2525	SH3025	SH3525	SH4025
SIZE	45	50	55	60	70	80	15-40	45-80
Ref. #	SH4525	SH5025	SH5525	SH6025	SH7025	SH8025	SH154025	SH458025

28MM

SIZE	08	10	15	20	25	30	35	40
Ref. #	SH0828	SH1028	SH1528	SH2028	SH2528	SH3028	SH3528	SH4028
SIZE	45	50	55	60	70	80	15-40	45-80
Ref. #	SH4528	SH5028	SH5528	SH6028	SH7028	SH8028	SH154528	SH458028

31MM

SIZE	08	10	15	20	25	30	35	40
Ref. #	SH0831	SH1031	SH1531	SH2031	SH2531	SH3031	SH3531	SH4031
SIZE	45	50	55	60	70	80	15-40	45-80
Ref. #	SH4531	SH5031	SH5531	SH6031	SH7031	SH8031	SH154031	SH458031



K File 21MM

SIZE	08	10	15	20	25	30	35	40
Ref. #	SK0821	SK1021	SK1521	SK2021	SK2521	SK3021	SK3521	SK4021
SIZE	45	50	55	60	70	80	15-40	40-80
Ref. #	SK4521	SK5021	SK5521	SK6021	SH7021	SH8021	SK154021	SK458021

25MM

SIZE	08	10	15	20	25	30	35	40
Ref. #	SK0825	SK1025	SK1525	SK2025	SK2525	SK3025	SK3525	SK4025
SIZE	45	50	55	60	70	80	15-40	40-80
Ref. #	SK4525	SK5025	SK5525	SK6025	SK7025	SK8025	SK154025	SK458025

28MM

SIZE	08	10	15	20	25	30	35	40
Ref. #	SK0828	SK1028	SK1528	SK2028	SK2528	SK3028	SK3528	SK4028
SIZE	45	50	55	60	70	80	15-40	40-80
Ref. #	SK4528	SK5028	SK5528	SK6028	SK7028	SK8028	SK154528	SK458028

31MM

SIZE	08	10	15	20	25	30	35	40
Ref. #	SK0831	SK1031	SK1531	SK2031	SK2531	SK3031	SK3531	SK4031
SIZE	45	50	55	60	70	80	15-40	40-80
Ref. #	SK4531	SK5031	SK5531	SK6031	SK7031	SK8031	SK154031	SK458031



Reamer File 21MM

SIZE	08	10	15	20	25	30	35	40
Ref. #	SR0821	SR1021	SR1521	SR2021	SR2521	SR3021	SR3521	SR4021
SIZE	45	50	55	60	70	80	15-40	40-80
Ref. #	SR4521	SR5021	SR5521	SR6021	SR7021	SR8021	SR154021	SR458021

25MM

SIZE	08	10	15	20	25	30	35	40
Ref. #	SR0825	SR1025	SR1525	SR2025	SR2525	SR3025	SR3525	SR4025
SIZE	45	50	55	60	70	80	15-40	40-80
Ref. #	SR4525	SR5025	SR5525	SR6025	SR7025	SR8025	SR154025	SR458025

28MM

SIZE	08	10	15	20	25	30	35	40
Ref. #	SR0828	SR1028	SR1528	SR2028	SR2528	SR3028	SR3528	SR4028
SIZE	45	50	55	60	70	80	15-40	40-80
Ref. #	SR4528	SR5028	SR5528	SR6028	SR7028	SR8028	SR154028	SR458028

31MM

SIZE	08	10	15	20	25	30	35	40
Ref. #	SR0831	SR1031	SR1531	SR2031	SR2531	SR3031	SR3531	SR4031
SIZE	45	50	55	60	70	80	15-40	40-80
Ref. #	SR4531	SR5031	SR5531	SR6031	SR7031	SR8031	SR154031	SR408031



SIZE	08	10	15	20	25	30	35	40
Ref. #	SS0821	SS1021	SS1521	SS2021	SS2521	SS3021	SS3521	SS4021
SIZE	45	50	55	60	70	80	15-40	45-80
21MM Ref. #	SS4521	SS5021	SS5521	SS6021	SS7021	SS8021	SS154021	SS458021

SIZE	08	10	15	20	25	30	35	40
Ref. #	SS0825	SS1025	SS1525	SS2025	SS2525	SS3025	SS3525	SS4025
SIZE	45	50	55	60	70	80	15-40	45-80
25MM Ref. #	SS4525	SS5025	SS5525	SS6025	SS7025	SS8025	SS154025	SS458025



SIZE	08	10	15	20	25	30	35	40
Ref. #	SP0821	SP1021	SP1521	SP2021	SP2521	SP3021	SP3521	SP4021
SIZE	45	50	55	60	70	80	15-40	45-80
21MM Ref. #	SP4521	SP5021	SP5521	SP6021	SP7021	SP8021	SP154021	SP458021

SIZE	08	10	15	20	25	30	35	40
Ref. #	SP0825	SP1025	SP1525	SP2025	SP2525	SP3025	SP3525	SP4025
SIZE	45	50	55	60	70	80	15-40	45-80
25MM Ref. #	SP4525	SP5025	SP5525	SP6025	SP7025	SP8025	SP154025	SP458025

Hand Use, NiTi



SIZE	08	10	15	20	25	30	35	40
Ref. #	NH0821	NH1021	NH1521	NH2021	NH2521	NH3021	NH3521	NH4021
SIZE	45	50	55	60	70	80	15-40	45-80
21MM Ref. #	NH4521	NH5021	NH5521	NH6021	NH7021	NH8021	NH154021	NH458021

SIZE	08	10	15	20	25	30	35	40
Ref. #	NH0825	NH1025	NH1525	NH2025	NH2525	NH3025	NH3525	NH4025
SIZE	45	50	55	60	70	80	15-40	45-80
25MM Ref. #	NH4525	NH5025	NH5525	NH6025	NH7025	NH8025	NH154025	NH458025

SIZE	08	10	15	20	25	30	35	40
Ref. #	NH0828	NH1028	NH1528	NH2028	NH2528	NH3028	NH3528	NH4028
SIZE	45	50	55	60	70	80	15-40	45-80
28MM Ref. #	NH4528	NH5028	NH5528	NH6028	NH7028	NH8028	NH154028	NH458028

SIZE	08	10	15	20	25	30	35	40
Ref. #	NH0831	NH1031	NH1531	NH2031	NH2531	NH3031	NH3531	NH4031
SIZE	45	50	55	60	70	80	15-40	45-80
31MM Ref. #	NH4531	NH5031	NH5531	NH6031	NH7031	NH8031	NH154031	NH458031



SIZE	08	10	15	20	25	30	35	40
Ref. #	NK0821	NK1021	NK1521	NK2021	NK2521	NK3021	NK3521	NK4021
SIZE	45	50	55	60	70	80	15-40	45-80
21MM Ref. #	NK4521	NK5021	NK5521	NK6021	NK7021	NK8021	NK154021	NK458021

SIZE	08	10	15	20	25	30	35	40
Ref. #	NK0825	NK1025	NK1525	NK2025	NK2525	NK3025	NK3525	NK4025
SIZE	45	50	55	60	70	80	15-40	45-80
25MM Ref. #	NK4525	NK5025	NK5525	NK6025	NK7025	NK8025	NK154025	NK458025

SIZE	08	10	15	20	25	30	35	40
Ref. #	NK0828	NK1028	NK1528	NK2028	NK2528	NK3028	NK3528	NK4028
SIZE	45	50	55	60	70	80	15-40	45-80
28MM Ref. #	NK4528	NK5028	NK5528	NK6028	NK7028	NK8028	NK154028	NK458028

SIZE	08	10	15	20	25	30	35	40
Ref. #	NK0831	NK1031	NK1531	NK2031	NK2531	NK3031	NK3531	NK4031
SIZE	45	50	55	60	70	80	15-40	45-80
31MM Ref. #	NK4531	NK5031	NK5531	NK6031	NK7031	NK8031	NK154031	NK458031



SIZE	08	10	15	20	25	30	35	40
Ref. #	NR0821	NR1021	NR1521	NR2021	NR2521	NR3021	NR3521	NR4021
SIZE	45	50	55	60	70	80	15-40	45-80
21MM Ref. #	NR4521	NR5021	NR5521	NR6021	NR7021	NR8021	NR154021	NR458021

SIZE	08	10	15	20	25	30	35	40
Ref. #	NR0825	NR1025	NR1525	NR2025	NR2525	NR3025	NR3525	NR4025
SIZE	45	50	55	60	70	80	15-40	45-80
25MM Ref. #	NR4525	NR5025	NR5525	NR6025	NR7025	NR8025	NR154025	NR458025

SIZE	08	10	15	20	25	30	35	40
Ref. #	NR0828	NR1028	NR1528	NR2028	NR2528	NR3028	NR3528	NR4028
SIZE	45	50	55	60	70	80	15-40	45-80
28MM Ref. #	NR4528	NR5028	NR5528	NR6028	NR7028	NR8028	NR154028	NR458028

SIZE	08	10	15	20	25	30	35	40
Ref. #	NR0831	NR1031	NR1531	NR2031	NR2531	NR3031	NR3531	NR4031
SIZE	45	50	55	60	70	80	15-40	40-80
31MM Ref. #	NR4531	NR5031	NR5531	NR6031	NR7031	NR8031	NR154031	NR458031



Spreader File 21MM

SIZE	08	10	15	20	25	30	35	40
Ref. #	NS0821	NS1021	NS1521	NS2021	NS2521	NS3021	NS3521	NS4021
SIZE	45	50	55	60	70	80	15-40	45-80
Ref. #	NS4521	NS5021	NS5521	NS6021	NS7021	NS8021	NS154021	NS458021

25MM

SIZE	08	10	15	20	25	30	35	40
Ref. #	NS0825	NS1025	NS1525	NS2025	NS2525	NS3025	NS3525	NS4025
SIZE	45	50	55	60	70	80	15-40	40-80
Ref. #	NS4525	NS5025	NS5525	NS6025	NS7025	NS8025	NS154025	NS458025



Plugger File 21MM

SIZE	08	10	15	20	25	30	35	40
Ref. #	NP0821	NP1021	NP1521	NP2021	NP2521	NP3021	NP3521	NP4021
SIZE	45	50	55	60	70	80	15-40	40-80
Ref. #	NP4521	NP5021	NP5521	NP6021	NP7021	NP8021	NP154021	NP458021

25MM

SIZE	08	10	15	20	25	30	35	40
Ref. #	NP0825	NP1025	NP1525	NP2025	NP2525	NP3025	NP3525	NP4025
SIZE	45	50	55	60	70	80	15-40	45-80
Ref. #	NP4525	NP5025	NP5525	NP6025	NP7025	NP8025	NP154025	NP458025

Engine Use,
Stainless Steel

Rec.R.P.M.: 180-350



H File 21MM

SIZE	08	10	15	20	25	30	35	40
Ref. #	ESH0821	ESH1021	ESH1521	ESH2021	ESH2521	ESH3021	ESH3521	ESH4021
SIZE	45	50	55	60	70	80	15-40	45-80
Ref. #	ESH4521	ESH5021	ESH5521	ESH6021	ESH7021	ESH8021	ESH154021	ESH458021

25MM

SIZE	08	10	15	20	25	30	35	40
Ref. #	ESH0825	ESH1025	ESH1525	ESH2025	ESH2525	ESH3025	ESH3525	ESH4025
SIZE	45	50	55	60	70	80	15-40	45-80
Ref. #	ESH4525	ESH5025	ESH5525	ESH6025	ESH7025	ESH8025	ESH154025	ESH458025



K File 21MM

SIZE	08	10	15	20	25	30	35	40
Ref. #	ESK0821	ESK1021	ESK1521	ESK2021	ESK2521	ESK3021	ESK3521	ESK4021
SIZE	45	50	55	60	70	80	15-40	45-80
Ref. #	ESK4521	ESK5021	ESK5521	ESK6021	ESK7021	ESK8021	ESK154021	ESK458021

25MM

SIZE	08	10	15	20	25	30	35	40
Ref. #	ESK0825	ESK1025	ESK1525	ESK2025	ESK2525	ESK3025	ESK3525	ESK4025
SIZE	45	50	55	60	70	80	15-40	45-80
Ref. #	ESK4525	ESK5025	ESK5525	ESK6025	ESK7025	ESK8025	ESK154025	ESK458025



Reamer File 21MM

SIZE	08	10	15	20	25	30	35	40
Ref. #	ESR0821	ESR1021	ESR1521	ESR2021	ESR2521	ESR3021	ESR3521	ESR4021
SIZE	45	50	55	60	70	80	15-40	45-80
Ref. #	ESR4521	ESR5021	ESR5521	ESR6021	ESR7021	ESR8021	ESR154021	ESR458021

25MM

SIZE	08	10	15	20	25	30	35	40
Ref. #	ESR0825	ESR1025	ESR1525	ESR2025	ESR2525	ESR3025	ESR3525	ESR4025
SIZE	45	50	55	60	70	80	15-40	45-80
Ref. #	ESR4525	ESR5025	ESR5525	ESR6025	ESR7025	ESR8025	ESR154025	ESR458025

Engine Use, NiTi

Rec.R.P.M.: 180-350



H File 21MM

SIZE	08	10	15	20	25	30	35	40
Ref. #	ENH0821	ENH1021	ENH1521	ENH2021	ENH2521	ENH3021	ENH3521	ENH4021
SIZE	45	50	55	60	70	80	15-40	45-80
Ref. #	ENH4521	ENH5021	ENH5521	ENH6021	ENH7021	ENH8021	ENH154021	ENH458021

25MM

SIZE	08	10	15	20	25	30	35	40
Ref. #	ENH0825	ENH1025	ENH1525	ENH2025	ENH2525	ENH3025	ENH3525	ENH4025
SIZE	45	50	55	60	70	80	15-40	45-80
Ref. #	ENH4525	ENH5025	ENH5525	ENH6025	ENH7025	ENH8025	ENH154025	ENH458025



K File 21MM

SIZE	08	10	15	20	25	30	35	40
Ref. #	ENK0821	ENK1021	ENK1521	ENK2021	ENK2521	ENK3021	ENK3521	ENK4021
SIZE	45	50	55	60	70	80	15-40	45-80
Ref. #	ENK4521	ENK5021	ENK5521	ENK6021	ENK7021	ENK8021	ENK154021	ENK458021

25MM

SIZE	08	10	15	20	25	30	35	40
Ref. #	ENK0825	ENK1025	ENK1525	ENK2025	ENK2525	ENK3025	ENK3525	ENK4025
SIZE	45	50	55	60	70	80	15-40	45-80
Ref. #	ENK4525	ENK5025	ENK5525	ENK6025	ENK7025	ENK8025	ENK154025	ENK458025



Reamer File 21MM

SIZE	08	10	15	20	25	30	35	40
Ref. #	ENR0821	ENR1021	ENR1521	ENR2021	ENR2521	SH3021	SH3521	SH4021
SIZE	45	50	55	60	70	80	15-40	45-80
Ref. #	ENR4521	ENR5021	ENR5521	ENR6021	ENR7021	ENR8021	ENR154021	ENR458021

25MM

SIZE	08	10	15	20	25	30	35	40
Ref. #	ENR0825	ENR1025	ENR1525	ENR2025	ENR2525	ENR3025	ENR3525	ENR4025
SIZE	45	50	55	60	70	80	15-40	45-80
Ref. #	ENR4525	ENR5025	ENR5525	ENR6025	ENR7025	ENR8025	ENR154025	ENR458025

NiTi Protaper
(Hand use)



SX: 19MM

Package: 6pcs/box

SIZE	SX	S1	S2	F1	F2	F3	SX-F3	21MM
Ref. #	NSX19	NS121	NS221	NF121	NF221	NF321	NSXF321	
SIZE		S1	S2	F1	F2	F3	SX-F3	25MM
Ref. #		NS125	NS225	NF125	NF225	NF325	NSXF325	

NiTi Protaper
(Engine Use)



Rec.R.P.M.: 150-350
SX: 19MM

SIZE	SX	S1	S2	F1	F2	F3	SX-F3	21MM
Ref. #	ENSX19	ENS121	ENS221	ENF121	ENF221	ENF321	ENSXF321	
SIZE		S1	S2	F1	F2	F3	SX-F3	25MM
Ref. #		ENS125	ENS225	ENF125	ENF225	ENF325	ENSXF325	

Paste Carriers
(Stainless Steel)



Rec.R.P.M.: 250-500
Package: 4cs/box

- Made of imported Stainless steel(Medical grade)
- Precision processing technology, good flexibility, high resistance to broken.

SIZE	25	30	35	40	25-40	
Ref. #	PC2521	PC3021	PC3521	PC4021	PC254021	21MM
SIZE	25	30	35	40	25-40	
Ref. #	PC2525	PC3025	PC3525	PC4025	PC254025	25MM
SIZE	25	30	35	40	25-40	
Ref. #	PC2529	PC3029	PC3529	PC4029	PC254029	29MM

Gates Drills

Rec.R.P.M.: 700-1100
Package: 6pcs/box



- High quality Stainless steel(Medical grade)
- For the provision of a root canal orifice, remove the root canal filling material and preparation.

SIZE	1	2	3	4	5	6	1-6	
Ref. #	G0128	G0228	G0328	G0428	G0528	G0628	G1628	28MM
SIZE	1	2	3	4	5	6	1-6	
Ref. #	G0132	G0232	G0332	G0432	G0532	G0632	G1632	32MM

Peeso Reamers

Rec.R.P.M.: 700-1100
Package: 6pcs/box



- High quality Stainless Steel(Medical grade)
- Used for crown one-third of root canal preparation, remove the root canal filling material and preparation.

SIZE	1	2	3	4	5	6	1-6	
Ref. #	P0128	P0228	P0328	P0428	P0528	P0628	P1628	28MM
SIZE	1	2	3	4	5	6	1-6	
Ref. #	P0132	P0232	P0332	P0432	P0532	P0632	P1632	32MM

Endo File Foam Inserts

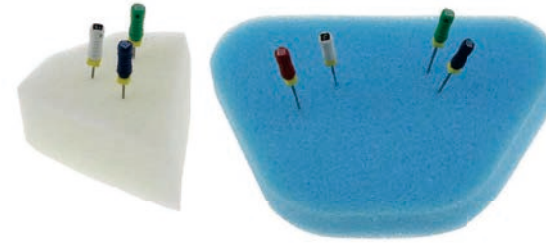

Ref.#	Description	Package
ED002-1	50*50*20(mm) White	48pcs/bag
ED002-2	100*69*13(mm) Blue	100pcs/bag

Endo Aid Kit & Refills



Ref.#	Description	Package
ED004-1	1big ring + 1small ring + 1foam	1set/bag
ED004-2	foam only	50pcs/bag

Endo Ruler



Ref.#	Description	Package
ED003-1	Autoclavable, stainless steel	1pcs/bag



Ref.#	Description	Package
ED003-2	Aluminum, Ring	1pcs/box
ED003-3	Aluminum, Straight	1pcs/box

Endo File holder



Ref.#	Description	Package
ED003-4	aluminium, 118*83*50mm	1pc/box



Ref.#	Description	Package
ED003-5	aluminium, 105*47*55mm	1pc/box

Endo File Holder

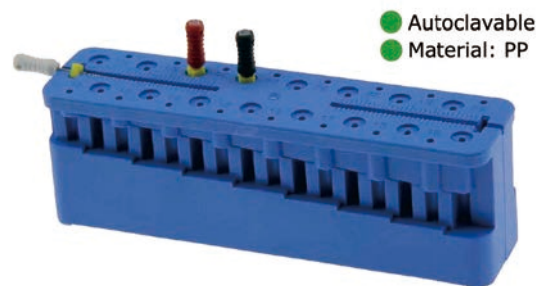

- Autoclavable
- Material: PP

Ref.#	Description	Package
ED004A-1	10X2.4X3.2cm, millimeter scale	1pcs/box



- Autoclavable
- Material: PC

Ref.#	Description	Package
ED004A-2	155X60X35mm	1pcs/box

Endo File Holder with Sponge



- Autoclavable
- Material: Polyamide

Ref.#	Description	Package
ED004A-3	45mm	1pc/box

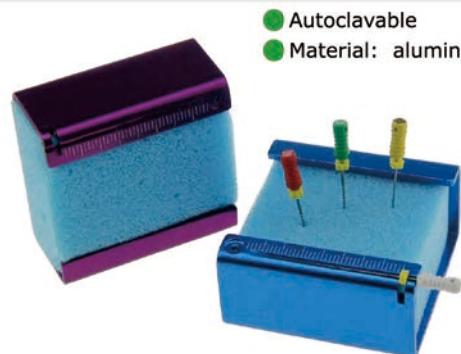

- Autoclavable
- Material: aluminium

Ref.#	Description	Package
ED004A-4	50*50*25mm	1pc/box

Gutta Percha Points



ISO.02

Ref.#	Description	Package
ED005-115	15#	120pcs/box
ED005-120	20#	120pcs/box
ED005-125	25#	120pcs/box
ED005-130	30#	120pcs/box
ED005-135	35#	120pcs/box
ED005-140	40#	120pcs/box
ED005-1	15-40#	120pcs/box
ED005-2	45-80#	120pcs/box
ED005-3	90-140#	60pcs/box



aluminium
With Mark

Ref.#	Description	Package
ED005M-115	15#	120pcs/box
ED005M-120	20#	120pcs/box
ED005M-125	25#	120pcs/box
ED005M-130	30#	120pcs/box
ED005M-135	35#	120pcs/box
ED005M-140	40#	120pcs/box
ED005M-1	15-40#	120pcs/box
ED005M-2	45-80#	120pcs/box
ED005M-3	90-140#	60pcs/box

GP Holder



- ED009-1
- Material: aluminium
 - 6 Holes
 - Size: 115*80*50mm



- ED009-2
- Material: aluminium
 - 6 Holes
 - Size: 62*47*55mm

Absorbent Paper Points



ISO.02

Ref.#	Description	Package
ED006-115	15#	200pcs/box
ED006-120	20#	200pcs/box
ED006-125	25#	200pcs/box
ED006-130	30#	200pcs/box
ED006-135	35#	200pcs/box
ED006-140	40#	200pcs/box
ED006-1	15-40#	200pcs/box
ED006-2	45-80#	200pcs/box
ED006-3	90-140#	100pcs/box



With Mark

Ref.#	Description	Package
ED006M-115	15#	200pcs/box
ED006M-120	20#	200pcs/box
ED006M-125	25#	200pcs/box
ED006M-130	30#	200pcs/box
ED006M-135	35#	200pcs/box
ED006M-140	40#	200pcs/box
ED006M-1	15-40#	200pcs/box
ED006M-2	45-80#	200pcs/box
ED006M-3	90-140#	100pcs/box

Notes: All dimension to be measured to an accuracy 0.05mm. A tolerance of ± 0.05 mm applies to D3, D16. Taper proportion is 0.02mm per 1mm at uniform taper. Overall length is not less than 28mm ± 0.01 mm unless otherwise specified.

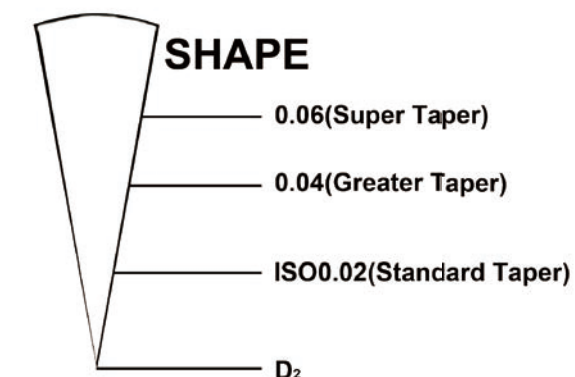
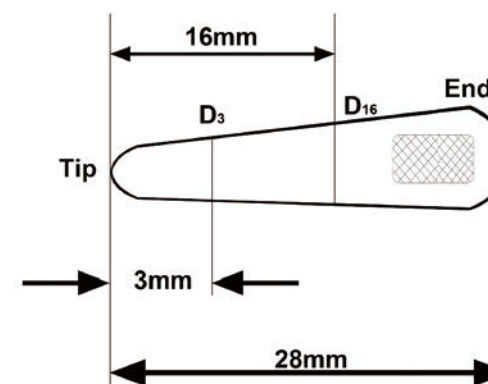

Non-Standard Points

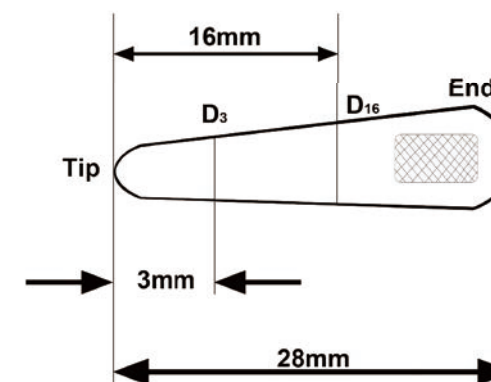

Ref.#	Description	Dia.D3 3mm From tip(mm)	Dia.D16 16mm From tip(mm)
ED008-1	XF	0.20	0.45
ED008-2	FF	0.24	0.56
ED008-3	MF	0.27	0.68
ED008-4	F	0.30	0.80
ED008-5	FM	0.35	0.88
ED008-6	M	0.40	1.10
ED008-7	ML	0.43	1.25
ED008-8	L	0.49	1.55
ED008-9	XL	0.52	1.60

Fiber POST



Glass Fiber Post - Straight

- Diameter: 1mm,1.2mm,1.4mm,1.6mm
- Length:17mm
- Fiber: 65%,Resin:35%

Ref.#	Description	Package
EP001	Fiber Post	5pcs/pack,4pack/box
EP001K	Fiber Post kit	20pcs post + 4 drills/box



Glass Fiber Post - Double Cone

- Diameter: 1.2mm,1.4mm,1.6mm,1.8mm
- Length:17mm
- Fiber: 65%,Resin:35%

Ref.#	Description	Package
EP002	Fiber Post	5pcs/pack,4pack/box
EP002K	Fiber Post kit	20pcs post + 4 drills/box

Fiber Post

Glass Fiber Post - Thread

- Diameter: 1.2mm,1.4mm,1.6mm,1.8mm
- Length:17mm
- Fiber: 65%,Resin:35%

Ref.#	Description	Package
EP003	Fiber Post	5pcs/pack,4pack/box
EP003K	Fiber Post kit	20pcs post + 4 drills/box



Quartz Fiber Post - Straight

- Diameter :1.0mm,1.2mm,1.4mm,1.6mm
- Length:17mm
- Fiber: 65%,Resin:35%

Ref.#	Description	Package
EP005	Fiber Post	5pcs/pack,4pack/box
EP005K	Fiber Post Kit	20pcs post + 4 drills/box



Quartz Fiber Post - Double Cone

- Diameter: 1.2mm,1.4mm,1.6mm,1.8mm
- Length:17mm
- Fiber: 65%,Resin:35%

Ref.#	Description	Package
EP006	Fiber Post	5pcs/pack,4pack/box
EP006K	Fiber Post Kit	20pcs post + 4 drills/box



Quartz Fiber Post - Thread

- Diameter: 1.2mm,1.4mm,1.6mm,1.8mm
- Length: 17mm
- Fiber: 65%,Resin:35%

Ref.#	Description	Package
EP008	Fiber Post	5pcs/pack,4pack/box
EP008K	Fiber Post Kit	20pcs post + 4 drills/box



Drills

- Dia.1.2mm,1.4mm,1.6mm,1.8mm

Ref.#	Description
EP010-1	dia.1.2mm
EP010-2	dia.1.4mm
EP010-3	dia.1.6mm
EP010-4	dia.1.8mm



Impression



ABS Impression Tray

- Disposable
- ABS material
- Package: 12pcs/bag, 10bags/ctn

IM001

1# Large Upper	2# Large Lower
3# Medium Upper	4# Medium Lower
5# Small Upper	6# Small Lower
7# Upper Right/Low Left	8# Up Left/Low Right
9# Upper Anterior	10# Lower Anterior



ABS Impression Tray

- Disposable
- ABS material
- Package: 12pcs/bag, 10bags/ctn

IM001A

1# Large Upper	2# Large Lower
3# Medium Upper	4# Medium Lower
5# Small Upper	6# Small Lower

Impression



ABS Impression Tray

- Disposable
- ABS material
- Package: 12pcs/bag, 10bags/ctn

IM001B

1# Large Upper	2# Large Lower
3# Medium Upper	4# Medium Lower
5# Small Upper	6# Small Lower
7# Upper Right/Low Left	8# Up Left/Low Right
9# Anterior	

ABS Impression Tray

- Disposable
- ABS material
- Package: 12pcs/bag, 50bags/ctn

IM002A

1# Large Upper	2# Large Lower
3# Medium Upper	4# Medium Lower
5# Small Upper	6# Small Lower
7# Upper Right/Low Left	8# Up Left/Low Right
9# Anterior	

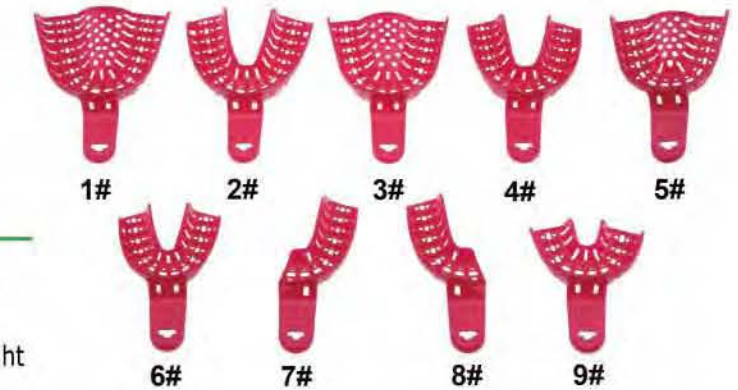

ABS Impression Tray

- Disposable
- ABS material
- Package: 12pcs/bag, 50bags/ctn

IM002B

1# Large Upper	2# Large Lower
3# Medium Upper	4# Medium Lower
5# Small Upper	6# Small Lower
7# Upper Right/Low Left	8# Up Left/Low Right
9# Upper Anterior	10# Lower Anterior

Autoclave Impression Tray

- Autoclavable
- PP material
- Package: 12pcs/bag, 50bags/ctn

IM003A

1# Large Upper	2# Large Lower
3# Medium Upper	4# Medium Lower
5# Small Upper	6# Small Lower
7# Upper Right/Low Left	8# Up Left/Low Right
9# Anterior	

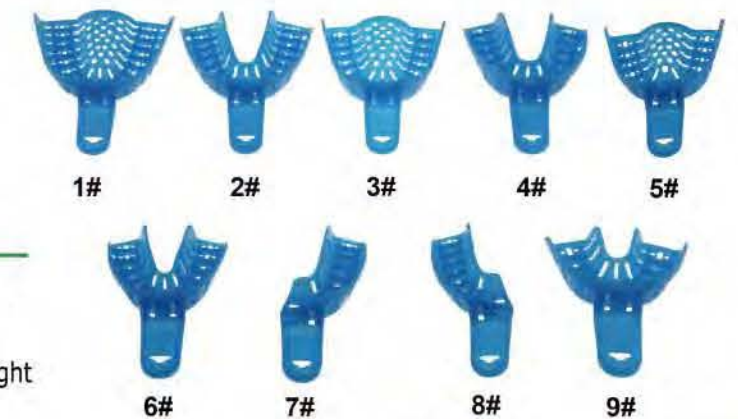



Impression

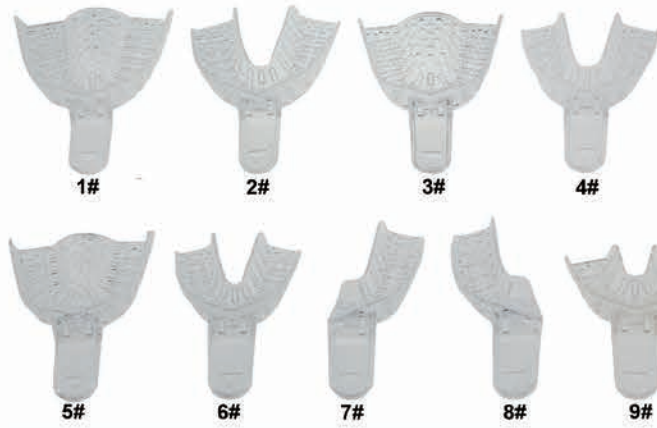

Impression Tray

- Disposable
- PS material
- Package: 12pcs/bag, 50bags/ctn

IM003B

1# Large Upper	2# Large Lower
3# Medium Upper	4# Medium Lower
5# Small Upper	6# Small Lower
7# Upper Right/Low Left	8# Up Left/Low Right
9# Anterior	

Superior Impression Tray For Orthodontics

- Disposable
- ABS material
- Package: 12pcs/bag, 30bags/ctn

IM003C

1# Large Upper	2# Large Lower
3# Medium Upper	4# Medium Lower
5# Small Upper	6# Small Lower
7# Extra small Upper	8# Extra small Lower



With Lock



Anodontia Impression Tray

- Autoclavable
- ABS material
- Package: 12pcs/bag, 30bags/ctn

IM003D

1# Large Lower	2# Large Lower
3# Medium Upper	4# Medium Lower
5# Small Upper	6# Small Lower

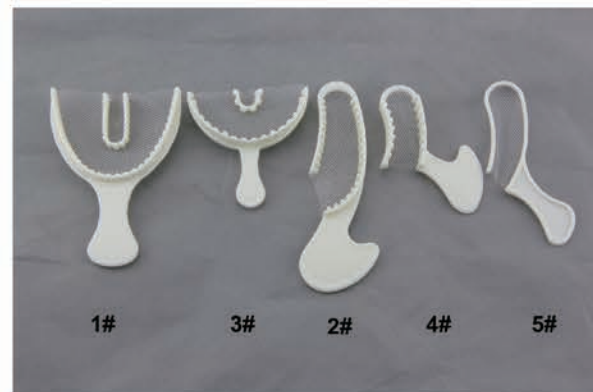

Impression Bite Registration Tray

- Disposable
- ABS material

IM004A

	Package
1# Large full	30pcs/bag, 20bag/ctn
2# Large half	35pcs/bag, 20bag/ctn
3# Small full	35pcs/bag, 20bag/ctn
4# Small half	50pcs/bag, 20bag/ctn
5# Extra small half	50pcs/bag, 20bag/ctn

Impression



Impression Bite Registration Tray

- Disposable
- ABS material

IM004B

	Package
1# Large full	30pcs/bag, 20bag/ctn
2# Large half	35pcs/bag, 20bag/ctn
3# Small full	35pcs/bag, 20bag/ctn
4# Small half	50pcs/bag, 20bag/ctn
5# Extra small half	50pcs/bag, 20bag/ctn

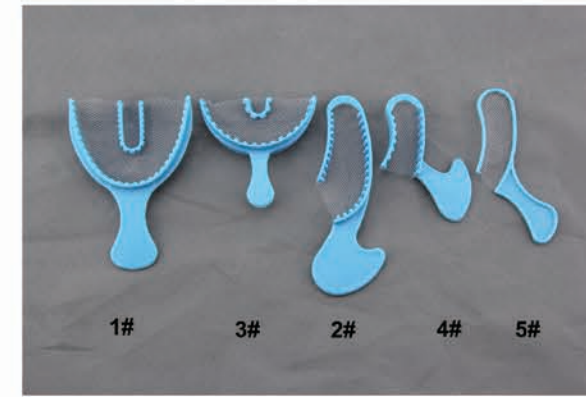

- Disposable
- ABS material

IM004C

	Package
1# Large full	30pcs/bag, 20bag/ctn
2# Large half	35pcs/bag, 20bag/ctn
3# Small full	35pcs/bag, 20bag/ctn
4# Small half	50pcs/bag, 20bag/ctn
5# Extra small half	50pcs/bag, 20bag/ctn

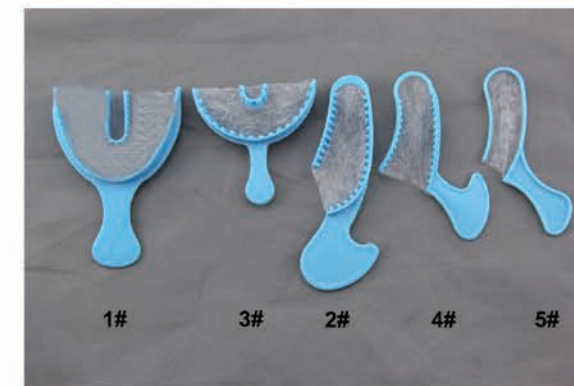

- Disposable
- Nonwoven

IM004D

	Package
1# Large full	30pcs/bag, 20bag/ctn
2# Large half	35pcs/bag, 20bag/ctn
3# Small full	35pcs/bag, 20bag/ctn
4# Small half	50pcs/bag, 20bag/ctn
5# Extra small half	50pcs/bag, 20bag/ctn

Fluoride Foam Tray

- Package: 50pcs/bag

IM005

1# Dual Arch, Large, blue
2# Dual Arch, Medium, yellow
3# Dual Arch, Small, green
4# Dual Arch, ExtraSmall, green
5# Single Arch, Large
6# Single Arch, Medium
7# Single Arch, Small

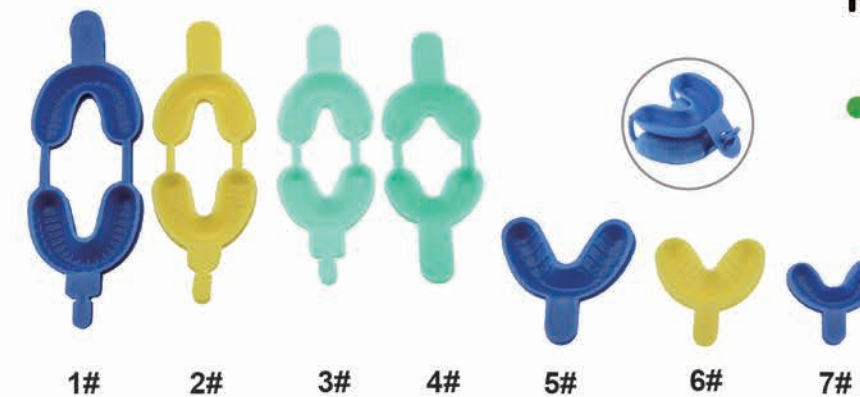

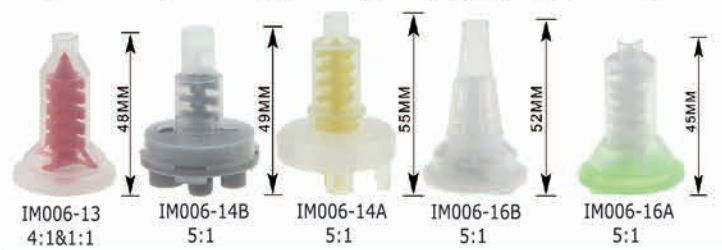
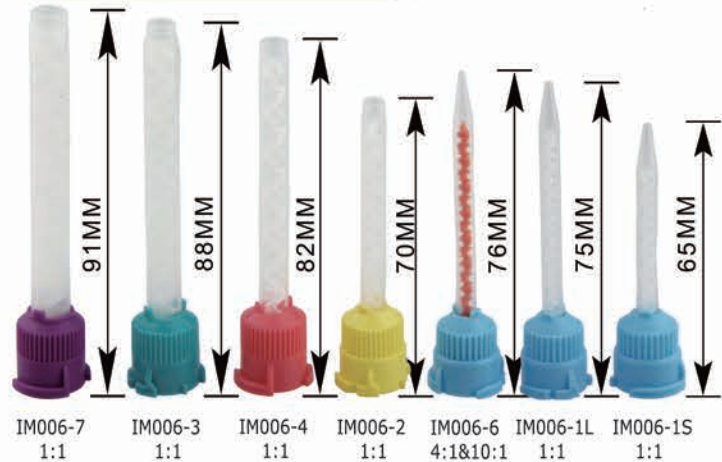

Impression Mixing Tips

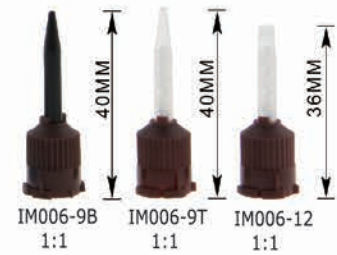

IM006
 ● Dynamic mixer compatible with 3M Penta, Zhermack, Dentsply, COLTENE machines. with most dynamic machine dispensed cartridges on the market.
 ● Package: 48pcs/bag

Intra-Oral Tips

● Package: 100pcs/bag



IM006-18
1:1



IM006-19
4:1&10:1



Mixer Gun

● Package: 1pcs/box, 20boxes/ctn

Dappen Dishes



IM008 Glass



IM009 Plastic

IM008 Glass
 ● 12pcs/box
 30box/ctn

IM009 Plastic
 ● 100pcs/box
 20box/ctn

Mortar and Pestle



IM010

● Tips provide precise placement interproximally
 ● Package: 2kits/box

Mini Mixing Wells



Ref. #	Description	Package
IM011-1	2 well	200pcs/box
IM011-2	4 well	44box/ctn



No-Stick Mixing cups

● Material: Silicone
 ● Washable for repeated Use

Glass Medicament Bottles



Ref. #	Description	Package
IM013-2	colors	20pcs/box

Efficient Cleaning Sponge



Ref. #	Description	Package
IM014	Foam: 20X25mm, Handle: 125mm	100pcs/bag

Bracket Trays

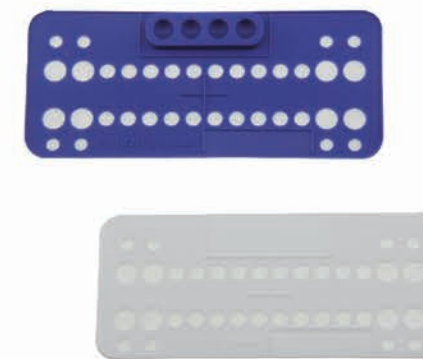

Ref. #	Description	Package
IM015-1	without mixing well	20pcs/box
IM015-2	with mixing well	20pcs/box

Set-Up Tray



Ref. #	Description	Package
IM016	Size: 336X240X23MM	40pcs/ctn



Impression

Cabinet tray



Ref.#	Description	Size
IM017-1	PP Medical grade	340X245X20MM



Ref.#	Description	Size
IM017-2	PP Medical grade	340X245X20MM

Plastic Trays

Disposable
Material:PS



Ref.#	Description	Package
IM018-1	190X148X15MM Flat	400pcs/ctn
IM018-2	190X148X15MM Convex	400pcs/ctn

Disposable
Material:PS



Ref.#	Description	Package
IM019-1	289X190X17 Flat	400pcs/ctn
IM019-2	289X190X17 Convex	400pcs/ctn

Instrument Kit Holder

Autoclavable

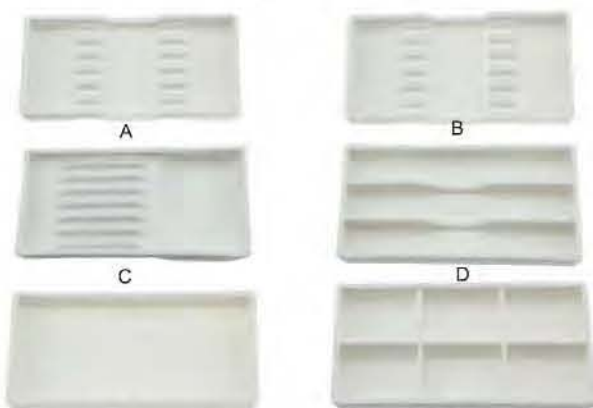

Ref.#	Description	Package
IM020-1	200X99X25MM	50pcs/ctn

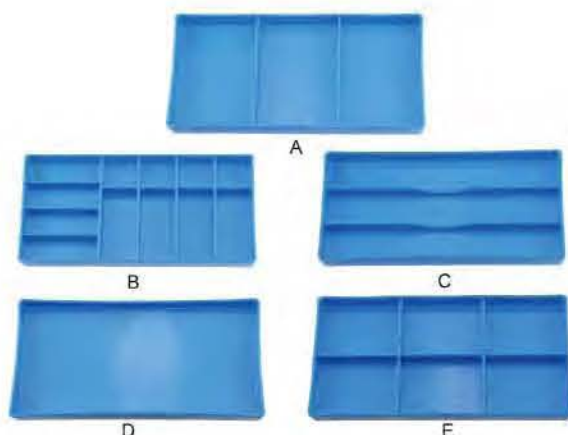

Ref.#	Description	Package
IM020-2	220X110X20MM	50pcs/ctn

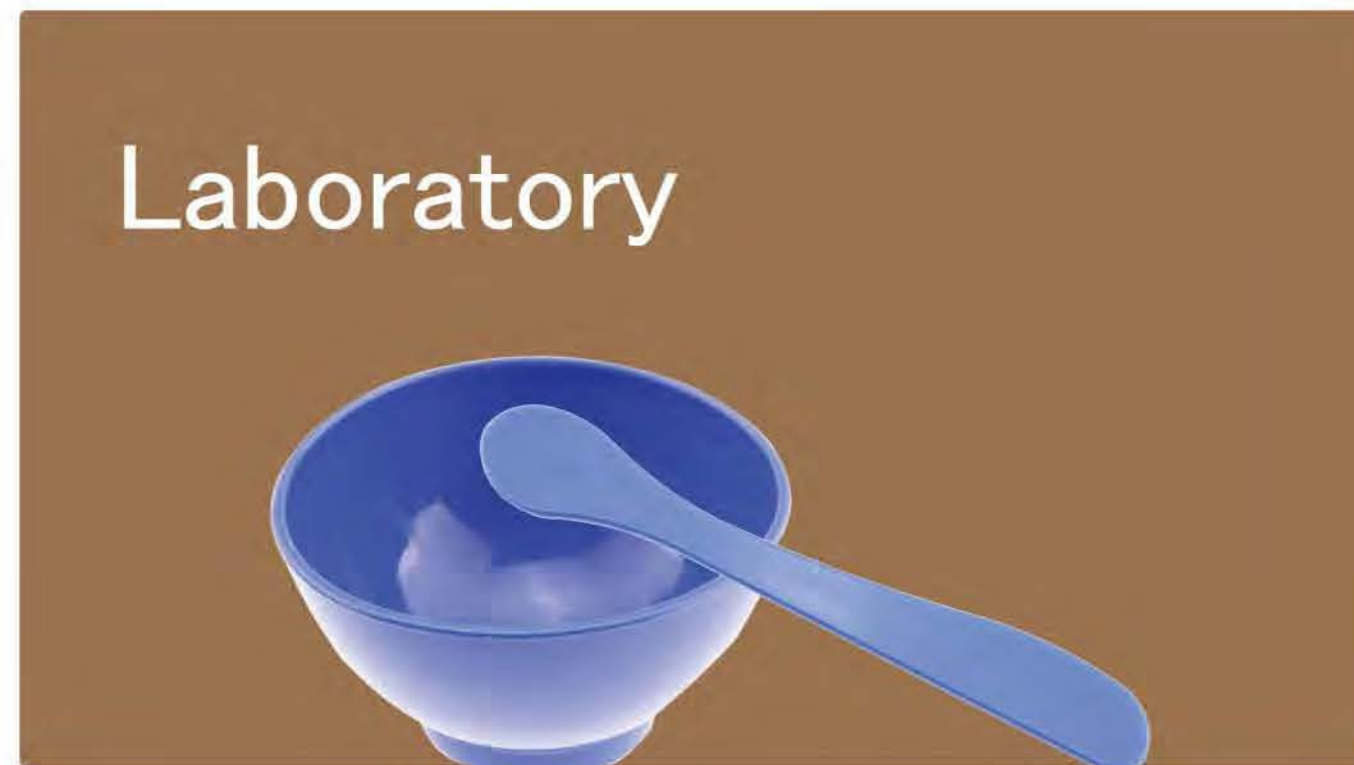

Laboratory

Mixing Bowls

- Material: PVC
- Color: blue,black,clear green, clear pink,clear blue



Ref.#	Size	Package
LB001-1	132X105mm	100pcs/ctn
LB001-2	118X72mm	180pcs/ctn
LB001-3	86.5X51.6mm	250pcs/ctn

Spatula



LB002-1

- Material: PP
- Flower type: 195*30mm
- Package: 25pcs/box,24boxes/ctn

LB002-2

- Material: PP
- Round end type:185X25mm
- Package:40pcs/box,24boxes/ctn



LB002-3

- Material: PP
- Handle type: 185*33mm
- Package: 40pcs/box, 20bags/ctn



LB002-4

- Material: PP
- Slim type: 110X4mm, white
- Package: 25pcs/box, 16boxes/ctn



Ortho Study Model Molds

LB003A

- Material: TPR
- Package: 6pcs/box, 30box/ctn

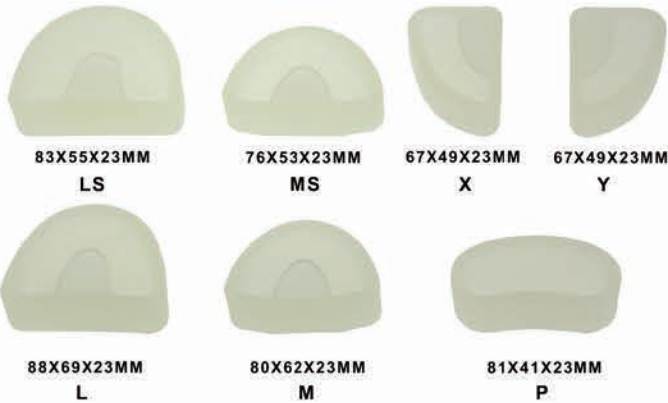

Ortho Study Model Molds

LB003B

- Material: TPE Medical grade
- Package: 6pcs/box, 30box/ctn

Alcohol Lamp



Ref.#	Description	Package
LB015	Blow lamp 100ml	1pc/box



Ref.#	Description	Package
LB016	Glass 125ml	1pc/box



Neaten Case



LB017

- Material: PP
- Slim type: 152X134X205mm
- Packing: 50pcs/ctn

Poly-coated Mixing Pad



- Used in conjunction with the spatula
- Coated paper 128g/m²
- 50pcs/book

Ref.#	Size	Package
LB022-1	2"*2"	10books/box, 60boxes/ctn
LB022-2	3"*3"	10books/box, 24boxes/ctn
LB022-3	3"*5"	5books/box, 32boxes/ctn
LB022-4	4"*5.5"	5books/box, 24boxes/ctn
LB022-5	4"*7"	5books/box, 20boxes/ctn
LB022-6	5.5"*7"	5books/box, 18boxes/ctn

Soft/Hard Plastic Sheet



LB023

- Mainly used in: Dental medical retainer and other products blister.
- Size: 125X125mm

Ref.#	Size (mm)	Package
LB023-1	Soft, Thickness: 1.0	20pcs/bag
LB023-2	Soft, Thickness: 1.5	15pcs/bag
LB023-3	Soft, Thickness: 2.0	10pcs/bag
LB023-4	Soft, Thickness: 3.0	10pcs/bag
LB023-5	Hard, Thickness: 1.0	20pcs/bag
LB023-6	Hard, Thickness: 1.5	15pcs/bag
LB023-7	Hard, Thickness: 2.0	10pcs/bag



Disposable Articulator

Ref.#	Description	Package
LB024-1B	Black	100pcs/bag
LB024-1C	Color	20bags/ctn



ABS Articulator

- Material: ABS

Ref.#	Description	Package
LB025	Color: blue,yellow	10pcs/bag 24bags/ctn

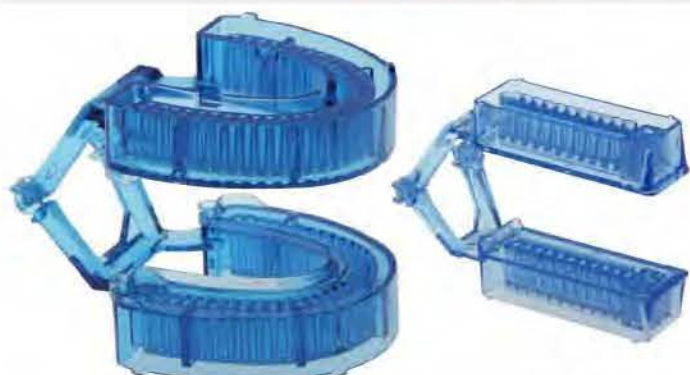

PS articulator

LB026

- Material: PS

Ref.#	Description	Package
LB026-1	Full mouth	55pcs/box
LB026-2	Half Mouth	60pcsbox

LB026-1

LB026-2



Disposable Pindex Board

LB027

- Material: ABS
- Packing: 100pcs/box, 6box/ctn



Disposable Plastic Model

LB028

- Material: PS
- Color: clear,pink,green,yellow
- Packing: 25pcs/bag, 40bag/ctn



Articulating Paper



Straight

Ref.#	Description	Package
AP001-1A	Top-grade Thick Blue,100 microns	10 books x 20sheets/box
AP001-2A	Top Grade Thick Red,100 microns	
AP001-1B	Common Thick Blue,100 microns	
AP001-2B	Common Thick Red,100 microns	
AP001-4	Common Thin Blue,50 microns	
AP001-5	Common Thin Red,30 microns	
AP001-6	Top-grade Thick Blue & Red,double 100 microns	12 books x 12sheets/box



Horse Shoe

Ref.#	Description	Package
AP001-7	Thick blue full Mouth,100 microns	6 books x 20sheets/box
AP001-8	Thick red full mouth,100 microns	
AP001-9	Thin blue full mouth,50 microns	6 books x 40sheets/box
AP001-10	Thin red,full mouth,30 microns	
AP001-11	Thick, full mouth,Blue & red double 100 microns	6 books x 12sheets/box



Straight

Ref.#	Description	Package
AP001-12	Occlusion Film,one-sided,blue,18um,50*22mm	200sheets/box
AP001-13	Occlusion Film,one-sided,red,18um,50*22mm	200sheets/box
AP001-14	Occlusion Film,two-sided,blue,18um,50*22mm	200sheets/box
AP001-15	Occlusion Film,two-sided,red,18um,50*22mm	200sheets/box

Orthodontic



Ligature Tie

OT001

- Non-latex material
- Anti-allergic
- Compact and solid
- One stick, one patient.
- Package: 936 ligature/bag

Power Chain

OT002

- An Ideal Solution For Difficult Treatments. This chain is both elastic and strong-lasts up to 6 weeks. Practical 15 ft/spool.

Ref.#	Description
OT002-1	Continue(without space)
OT002-2	short(short space)
OT002-3	Long(long space)



Separator

OT003

- It's used to isolate the gap with rings in 0.3mm. Generally, one ring can be extended to circle 3 to 7 teeth.
- Package: 720pcs/bag

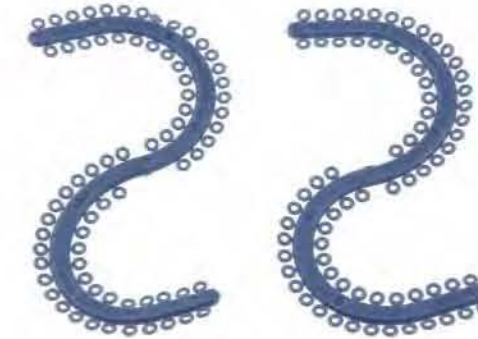

001	Bule	010	Dark Orange	019	Orchid	028	Darkmagenta
002	Light Blue	011	white	020	Blue violet	029	Cadet blue
003	Spring green	012	Clear	021	Light Pink	030	Metal blue
004	Black	013	Metal gray	022	Hot Pink	031	Dark blue
005	Lime	014	Brown	023	Red	032	Metal Brown
006	Green	015	Golden	024	Dark red	033	Semitransparent yellow
007	Dark green	016	Orange	025	Fuchsia	034	Semitransparent green
008	Forest green	017	Yellow	026	Royal blue	035	Semitransparent yellow
009	Orange red	018	Indigo	027	Toothcolor	036	Firebrick

Natural Elastics

- Package: 100pcs/bag, 50bags/box



Ref.	Description
OT004-1	Medium 3.5OZ,1/8",3.18mm
OT004-2	Medium 3.5OZ,3/16",4.76mm
OT004-3	Medium 3.5OZ,1/4",6.35mm
OT004-4	Medium 3.5OZ,5/16",7.94mm
OT004-5	Medium 3.5OZ,3/8",9.35mm

Ligature Tie Gun



OT005

- Package: 1pcs/blister

Brace Mouthguard



OT006

- Package: 1pcs/box

Sterilization



Self-sealing Sterilization Pouch



- Medical-grade, non-recycled kraft paper. Lead-free inks.
- Package: 200pcs/box

Ref. #	Description	Package
SP001-1	57X100MM	30box/ctn
SP001-2	90X230MM	20box/ctn
SP001-3	135X255MM	15box/ctn
SP001-4	190X300MM	10box/ctn
SP001-5	250X370MM	5box/ctn
SP001-6	305X380MM	5box/ctn
SP001-7	57X70MM	30box/ctn
SP001-8	70X135MM	30box/ctn
SP001-9	70X230MM	20box/ctn
SP001-10	90X135MM	30box/ctn
SP001-11	135X225MM	15box/ctn
SP001-12	190X330MM	10box/ctn

Flat Sterilization Reel Roll



Ref. #	Description	Package
SP002-1	50mm X 200m	12rolls/ctn
SP002-2	75mm X 200m	8rolls/ctn
SP002-3	100mm X 200m	6rolls/ctn
SP002-4	150mm X 200m	4rolls/ctn
SP002-5	200mm X 200m	4rolls/ctn
SP002-6	300mm X 200m	2rolls/ctn
SP002-7	55mm X 200m	10rolls/ctn
SP002-8	250mm X 200m	2rolls/ctn
SP002-9	350mm X 200m	1roll/ctn
SP002-10	400mm X 200m	1roll/ctn

Sterilization

Gusseted Sterilization Reel Roll



Ref. #	Description	Package
SP003-1	(75+20)mm X 100m	8rolls/ctn
SP003-2	(100+20)mm X 100m	6rolls/ctn
SP003-3	(150+30)mm X 100m	4rolls/ctn
SP003-4	(200+40)mm X 100m	4rolls/ctn
SP003-5	(300+50)mm X 100m	2rolls/ctn
SP003-6	(250+40)mm X 100m	2rolls/ctn
SP003-7	(350+50)mm X 100m	1rolls/ctn
SP003-8	(400+60)mm X 100m	1rolls/ctn

Sterilization Tape



Ref. #	Description	Ref. #	Description
SP004-1	EO, 12mmX50m	SP004-4	Autoclave, 12mmX50m
SP004-2	EO, 19mmX50m	SP004-5	Autoclave, 19mmX50m
SP004-3	EO, 25mmX50m	SP004-6	Autoclave, 25mmX50m

EO Sterilization Indicator



SP005

- Stored in the dark room in 15°C ~ 30°C, 50% relative humidity.
- Shelf span: 24 months.
- Package: 40pcs/paper

Sterilization Reel Sealing Machine



SM200

- Table Model
- Power supply: 220V, 50Hz, Power: 500W
- Sealing width (Max.): 250mm
- Impress width: 10mm
- Size: 500*270*390mm
- Weight: 6 KGS



SM400

- Automatic, used for all size
- Voltage: 220V, 50Hz, Power: 300W
- Size: 300X230X130mm
- Weight: 8KGS



SM300

- Power supply: 220V/50-60Hz, Power: 500W
- Fusion tube: T3A
- Seal width: 250mm, Mark width: 10mm
- size: 430X340X250mm
- Weight: 6.5KGS



SM100

- Ergonomic design, Wall mountable
- Voltage 230V, 50Hz, Power: 100W
- Seal width (Max.): 250mm, Mark width: 10mm
- Seal duration: 3S
- Size: 480X330X280mm
- Weight: 8KGS

BD Products

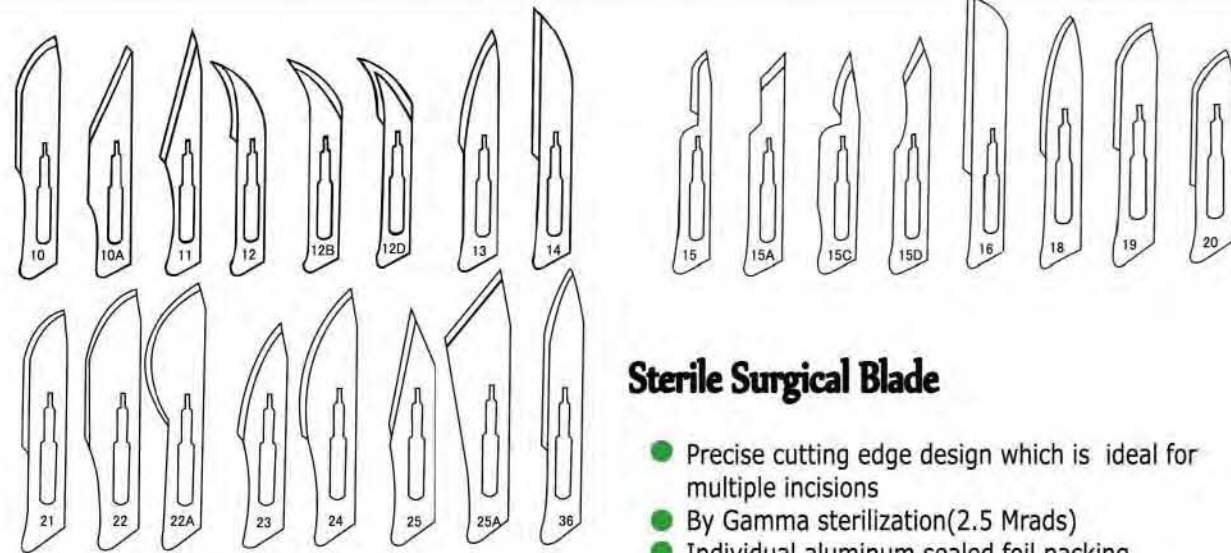

Sterile Surgical Blade

- Precise cutting edge design which is ideal for multiple incisions
- By Gamma sterilization(2.5 Mrads)
- Individual aluminum sealed foil packing
- Package: 100pcs/box,50box/ctn

Ref.#	Description
BD001-1	Carbon
BD001-2	Stainless Steel

Stainless Steel Scalpel Handle



Ref.# BD003

Sterile Disposable Scalpels

- By Gamma sterilizationn (2.5 Mrads)
- Individual aluminum sealed foil packing
- Package: 10pcs/box, 50box/ctn

Ref.#	Description
BD002-1	10-25#,Carbon Steel
BD002-2	10-25#,Stainless Steel



Sterile Suture Needles with Thread

- Usage: This kind of product is used in microsurgery, the surgery of the heart and the chest and the blood vessel, ophthalmic surgery and the soft tissues of internal organs. This kind of product is sealed and packed by the compound material of polyester and aluminum foil and polyester packing material. It is sterilized by the Gama and can be used directly without being re-sterilized before use.
- Package:12pcs/box,50boxes/ctn

Types of Needle Shape

- 1/2 Circle ● ○ ▲ ▼ ⊙ ▼ (8mm-60mm)
- 3/8 Circle ● ○ ▲ ▼ ⊙ ▼ (8mm-60mm)
- 5/8 Circle ● ○ ▲ ▼ ⊙ ▼ (8mm-60mm)
- Straight cutting ● ○ ▲ ▼ ⊙ ▼ (30mm-90mm)

Description Of Needle Type

DESCRIPTION OF NEEDLE TYPE

SYMBOL	POINT TYPE
●	TAPER POINT
○	BLUNT TAPERPOINT
▲	CUTTING EDGE
▼	REVERSE CUTTING EDGE
⊙	MICRO-POINT
▼	MICRO-POINT REVERSE CUTTING
▼	MICRO-POINT SPATULA CURVED

END TYPE	
	ROLLED-END
	DRILLED-END
	REGULAR-END

Needle Shape

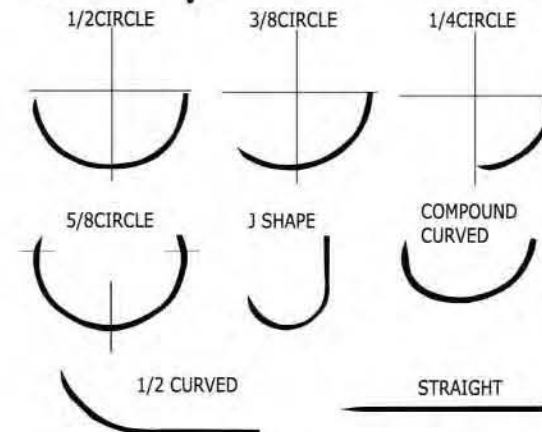

SUTURE MATERIALS



Chromic Catgut (Absorbable) Suture

BD004-1



Component parts: made from purified animal intestines (beef of sheep).
 Structure: Monofilament, Smooth Surface.
 Absorbtion: By enzymatic digestion. Complete from 90 days.
 Color: Green or Tan.
 Diameters of sutures: USP6/0-4
 Sterilization: By Gama Radiation.

Plain Catgut (Absorbable) Suture

BD004-2



Component parts: made from purified animal intestines (beef of sheep). Structure: Monofilament, Smooth Surface.
Absorbtion: By enzymatic digestion. Complete from 90 days.
Color: Straw
Diameters of sutures: USP6/0-4
Sterilization: By Gama Radiation.

Silk (Braided) Suture

BD004-3

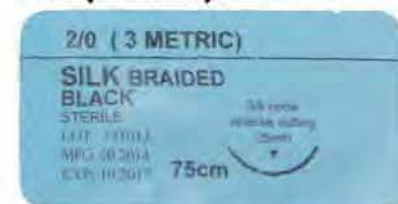

Component parts: Natural Silk, Structure: braided
Absorbtion: Non-absorbable.
Color: Black or Ivory
Diameters of sutures: USP6/0-4
Sterilization: By Gama Radiation.

Polyester (Braided) Suture

BD004-4



Component parts: Polyester, Structure: braided
Absorbtion: Non-absorbable.
Color: Green or blue
Diameters of sutures: USP6/0-3
Sterilization: By Gama Radiation.

Nylon (Non-absorbable) Suture

BD004-5



Component parts: Polyamide (Nylon)
Structure: Monofilament, Smooth Surface.
Absorbtion: Non-absorbable.
Color: Black or Blue
Diameters of sutures: USP11/0-3
Sterilization: By Gama Radiation.

Polypropylene Suture

BD004-6



Component parts: Polypropylene
Structure: Monofilament, Smooth Surface.
Absorbtion: Non-absorbable.
Color: Blue
Diameters of sutures: USP6/0-3
Sterilization: By Gama Radiation.

PGA (Polyglycolic Acid)

BD004-7



Component parts: Ethanoic Acid, Lactic Acid
Structure: Stranded Tight Braided
Absorbtion: By hydrolysis. Complete between 60 -90 days
Color: Violet or Undyed
Diameters of sutures: USP8/0-2
Sterilization: By Ethylene Oxide

X-Ray Accessories



Intraoral Dental X-ray film



XI004 E-Speed

- Process Condition and Method
Choose dental film wash machine: 3-5 minutes.
Choose manual operation: washing liquid temperature 18 °C-20°C, developed for 3-5 minutes, fixed for 10 minutes, wash for 30 minutes.

- Exposure Conditions

20cm(8in),70KV,7mA			
Upper Teeth	Time	Lower Teeth	Time
321 ↑ 123	0.15s	321 ↓ 123	0.13s
654 ↑ 456	0.20s	654 ↓ 456	0.14s
87 ↑ 78	0.25s	87 ↓ 78	0.15s

Ref.#	Description	Package
XI004	E-speed,Adult film 30X40mm	150pcs/box

XI007 D-Speed

- Exposure Conditions
- | 20cm(8in),70KV,8mA | | | |
|--------------------|-------|-------------|-------|
| Upper Teeth | Time | Lower Teeth | Time |
| 321 ↑ 123 | 0.40s | 321 ↓ 123 | 0.34s |
| 654 ↑ 456 | 0.54s | 654 ↓ 456 | 0.34s |
| 87 ↑ 78 | 0.60s | 87 ↓ 78 | 0.40s |

Ref.#	Description	Package
XI007	D-speed,Adult film 30X40mm	100pcs/box



XI010-1



XI010-2

X-ray Film Holders

- Take both anterior and posterior film
- Autoclavable 135°C
- Package: 3pcs/box,200box/ctn

Ref.#	Description
XI010-1	Reusable, straight ends
XI010-2	Reusable, 45° ends



BE-2 IP BE-1 BE-3 BE-4



0# 1# 2# 3# 4#

Barrier Envelopes

Ref.#	Description	Package
XI011-1	0#(22X35mm)	300pcs/box
XI011-2	1#(24X40mm)	300pcs/box
XI011-3	2#(31X41mm)	300pcs/box
XI011-4	3#(27X54mm)	200pcs/box
XI011-5	4#(57X76mm)	200pcs/box



X-ray Film Mounts-Clip On

Ref.#	Description	Package
XI012-1	2 Slots	100pcs/bag
XI012-2	4 Slots	100pcs/bag
XI012-3	6 Slots	100pcs/bag
XI012-4	14 Slots	100pcs/bag



X-ray Film Washer Clip

Stainless Steel

Ref.#	Description	Ref.#	Description
XI013-1	Single	XI013-5	5 Units
XI013-2	2 Units	XI013-6	7 Units
XI013-3	3 Units	XI013-7	8 Units
XI013-4	4 Units		



X-ray Film Mounts-Clip On

- Used for patients document the films and fill in patients' name and other information.



Ref.#	Description	Package
XI014-1	1 Slots	100pcs/bag
XI014-2	2 Slots	100pcs/bag
XI014-3	4 Slots	100pcs/bag
XI014-4	6 Slots	100pcs/bag
XI014-5	8 Slots	100pcs/bag



XI015-1



XI015-2



XI015-3



XI015-4



XI015-5



XI015-6



XI015-7



XI015-8



XI015-9

X-ray Film Bag

XI015

- Used for patient's documentary films and fill in patient's name and other information.
- Package: 100pcs/bag

Ref.#	Description
XI015-1	6 Pockets
XI015-2	8 Pockets
XI015-3	2 Pockets
XI015-4	4 Pockets
XI015-5	4 Pockets
XI015-6	8 Pockets
XI015-7	10 Pockets
XI015-8	6 Pockets
XI015-9	18 Pockets



POCKET-STYLE X-RAY IMAGE MOUNTS

XI015-10

- Transparent pockets suits for x-ray film
- Roll of 500 stripes of 2 mounts
- Package: 1roll/box

X-Ray Film Holder



Ref. #	Description	Package
XI016-1	Anterior, right, left, autoclavable	3set/box
XI016-2	Anterior, right, left, non-autoclavable	3set/box



Ref. #	Description	Package
XI017	Anterior, right, left, autoclavable	3set/box

Dental Barriers



Dental Barrier Film



Ref. #	Description	Package
DB001-1	4"X6", Blue, stick edge	12box/ctn
DB001-2	4"X6", Clear, stick edge	12box/ctn
DB001-3	4"X6", Blue, non-stick edge	12box/ctn
DB001-4	4"X6", Clear, non-stick edge	12box/ctn
DB001-5	6"X9", Blue, non-stick edge	8box/ctn
DB001-6	6"X9", Clear, non-stick edge	8box/ctn

Dental Barrier Film Dispenser



Ref. #	Description	Package
DB002-1	For 4"X6" barrier film	1pcs/box, 12boxes/ctn
DB002-2	For 6"X9" barrier film	1pcs/box, 8boxes/ctn

Syringe Sleeve



Ref. #	Description	Package
DB003-1	2-1/2"X10", 2.4s, blue	500pcs/box
DB003-2	2-1/2"X10", 2.4s, clear	36boxes/ctn
DB003-3	2.2"X17.7", 2.75s, clear roll type	250pcs/roll 18boxes/ctn

Mouth Mirror Sleeve



Ref. #	Description	Package
DB004	1-1/2"X8", 2.3s, clear	500pcs/box 36boxes/ctn



High/low speed Handpiece Sleeve



Ref.#	Description	Package
DB005-1	1-1/2"X8", 2.75s, low speed	500pcs/box
DB005-2	1"X8", 2.75s, high speed	36boxes/ctn

Light / T-style Light Handle Sleeve



Ref.#	Description	Package
DB006-1	4"X5-3/4", 2.9s, clear	500pcs/box
DB006-2	6"X2-9/10", 2.9S, clear	36box/ctn

Tray Sleeve



Ref.#	Description	Package
DB007-1	11-5/8"X16", 2s, clear	500pcs/box
DB007-2	10-1/2"X14", 2s, clear	6boxes/ctn

Head Rest Sleeve



Ref.#	Description	Package
DB008-1	10"X11", 2s, clear	250pcs/box
DB008-2	10"X14", 2s, clear	12boxes/ctn
DB008-3	11.8"X9", 3s roll type	250pcs/box 8boxes/ctn

Half/Full Chair Sleeve



Ref.#	Description	Package
DB009-1	Half, 27-1/2"X24", 1.7s, clear	225pcs/box 3boxes/ctn
DB009-2	Full, thick, 29"X80", 2s, clear	125pcs/box 3boxes/ctn
DB009-3	Full, 48"X56", 2s, clear	150pcs/box 3boxes/ctn
DB009-4	Full, thin, 29"X80", 1.34s, clear	125pcs/box 3boxes/ctn

X-ray Machine Sleeve



Ref.#	Description	Package
DB010	15"X26", 2.25s,	250pcs/box 4boxes/ctn

Air/water Syringe Sleeve



Ref.#	Description	Package
DB011	7-3/10"X5", 2s	500pcs/box 36boxes/ctn

Scaler Sleeve



Ref.#	Description	Package
DB012-1	1-3/5"X8", 2.75s, clear	500pcs/box
DB012-2	1-4"X7", 2.75s, clear	36box/ctn

X-ray Sensor Sleeve



Ref.#	Description	Package
DB014-1	2-1/2"X10", 2.4s, clear	500pcs/box
DB014-2	8"X1-5/8", 2s, clear	36box/ctn

Clip Cord Sleeve



Ref.#	Description	Package
DB016-1	2"X24", 3s, clear	250pcs/box 12boxes/ctn

Turbine Sleeve



Ref.#	Description	Package
DB017-1	1.8"X17.7", 2.75s, clear roll type	250pcs/box 18box/ctn



Intra Oral Camera Sleeve



Ref.#	Description	Package
DB013-1	9-4/5"X2", 1.5s, clear	100pcs/box 36boxes/ctn
DB013-2	10.2"X2", 2.5s, Pen type	500pcs/box 36boxes/ctn

Curing Light Sleeve/Guide sleeve/ Light Curing Probe



Ref.#	Description	Package
DB015-1	13.4"X3.3", 2.5s	500pcs/box, 20box/ctn
DB015-2	13.4"X2.1", 2.5s	500pcs/box, 36box/ctn
DB015-3	12.4"X4.13, 2.5s	500pcs/box, 36box/ctn
DB015-4	9.9X1.85", 2.5s	500pcs/box, 36box/ctn
DB015-5	4.33"X2.95", 3s	200pcs/box, 42box/ctn
DB015-6	4.33"X2.95", 3s	200pcs/box, 42box/ctn
DB015-7	4.7"X1.2", 1.5s	200pcs/box, 36box/ctn

Machine Sleeve



Ref.#	Description	Package
DB018	5"X5", 3s	500pcs/box 16boxes/ctn

Diamond Bur & Discs Polisher



ISO143010	ISO143012	ISO143014	ISO143016	ISO143018	ISO001007	ISO001008	ISO001010	ISO001011	ISO001012	ISO001014	ISO001015	ISO001016	ISO001018	ISO001020	ISO001022
SR-41	SR-42	SR-43	SR-44	SR-45	BR-50	BR-49	BR-46	BR-45	BR-41	BR-40	BR-31	BR-30	BR-29		
4	4	4	4	4	0.7	0.8	1	1.2	1.4	1.6	1.8	2.0	2.3		
19	19	19	19	19	19	19	19	19	19	19	19	19	19		
ISO062014	ISO062016	ISO062018	ISO062020	ISO062022	ISO062024	ISO062026	ISO062028	ISO062030	ISO062032	ISO062034	ISO062036	ISO062038	ISO062040	ISO062042	ISO062044
BC-43	BC-S42	BC-S43	SI-45	SI-46	SI-47	SI-48	SI-49	SI-S46	SI-S47	SI-S48	DI41	DI42	DI43		
2.7	2.3	2.7	1.5	1.6	1.8	1.8	2.5	1.2	1.4	1.6	2.0	2.5	2.5		
19	16.5	16.5	19	19	19	19	19	16.5	16.5	16.5	19	19	19		
ISO238014	ISO238016	ISO238018	ISO238020	ISO238022	ISO238024	ISO238026	ISO238028	ISO238030	ISO238032	ISO238034	ISO238036	ISO238038	ISO238040	ISO238042	ISO238044
SO-23	SO-S18	SO-S20	SO-S19	EX-22	EX-20	EX-21	EX-31	EX-41	WR-11	WR-12	WR-13	WR-14	EX-11		
8	6	6	6	7	5	5	4.5	3.0	1	1.5	2	2	5		
22	18	18	18	21	19	19	19	19	19	19	19	19	19		
ISO277012	ISO277014	ISO277016	ISO277018	ISO277020	ISO299014	ISO299016	ISO299018	ISO299020	ISO299022	ISO299024	ISO299026	ISO299028	ISO299030	ISO299032	ISO299034
FO-28	FO-29	FO-30	FO-31	ZJ-11	ZJ-12	ZJ-13	ZJ-14	ZJ-19	ZJ-20	ZJ-21	ZJ-S19	ZJ-S20	ZJ-S21		
2.5	2.5	3	4	10	10	10	9	7	7	7	7	7	7		
20	19	19	19	24	22	22	22	21	21	21	21	21	21		
ISO197016	ISO197022	ISO240021	ISO220017												
LG-SS21	LG-28	LG-29	EX-24	EX-25	EX-26	TF-11C	TF-12C	TF-13C	TF-14C	TF-20C	TF-21C	TF-S20C	TF-S21C		
7	5	5	10	5	2	10	10	10	9	7	7	7	7		
18	20	19	24	20	19	24	22	22	22	21	21	19	19		

Diamond Bur

Grit: Coarse Ref.# Head L mm Total L mm	ISO198016 TF-SS21C 7 18	ISO198014 TR-11C 10 22	ISO198016 TR-12C 10 22	ISO198018 TR-13C 9 22	ISO198022 TR-14C 9 22	ISO198018 TR-62C 7 20	ISO198014 TR-20C 7 21	ISO197016 TR-21C 7 21	ISO197014 TR-S20C 7 19	ISO197016 TR-S21C 7 19	ISO197016 TR-SS21C 7 18	ISO198018 TC-11C 10 22
Grit: Coarse Ref.# Head L mm Total L mm	ISO143016 SR-13C 8 22	ISO143012 SR-20C 7 21	ISO143014 SR-21C 7 21	ISO143018 SR-23C 7 21	ISO143022 SR-24C 7 21	ISO143010 SR-41C 4 19	ISO143012 SR-42C 4 19	ISO143014 SR-43C 4 19	ISO207016 FO-32C 4 19	ISO198018 FO-54C 9.5 21	ISO001018 BR-31C 1.8 19	ISO001016 BR-40C 1.6 19
Grit: Fine Ref.# Head L mm Total L mm	ISO247007 CD-57F 4 16.5	ISO198008 CD-58F 3.5 16.5	ISO171013 CD-59F 6.5 16.5	ISO173016 TF-12F 10 22	ISO171016 TF-21F 8 21	ISO198014 TR-11F 10 22	ISO198016 TR-12F 10 22	ISO197016 TR-21F 7 21	ISO198016 TR-25F 10 21.5	ISO198018 TR-26F 8.5 21.5	ISO143016 TC-11F 10 22	ISO160014 TC-21F 8 22
Grit: Fine Ref.# Head L mm Total L mm	ISO473009 EX-02F 0.5 19	ISO468011 EX-03F 3 19	ISO001006 CD-L50F 0.6 19	ISO138007 CD-L51F 2.3 19	ISO138007 CD-L52F 3.5 19	ISO181007 CD-L53F 2.5 19	ISO060006 CD-L54F 2.5 19	ISO254009 CD-L55F 1.2 19	ISO246007 CD-L56F 2.5 19	ISO247007 CD-L57F 4 19	ISO198008 CD-L58F 3.5 19	ISO171013 CD-L59F 6.5 19
Grit: Super Fine Ref.# Head L mm Total L mm	ISO198012 SF-42EF 4 19	ISO116012 SR-11EF 8 22	ISO143014 SR-21EF 7 21	ISO143010 SR-41EF 4 19	ISO142012 SR-42EF 4 19	ISO288012 SO-20EF 6 21	ISO288012 SO-21EF 8 22	ISO186014 TC-11EF 10 22	ISO186014 TC-21EF 8 22	ISO248012 FO-20EF 7 21	ISO248014 FO-21EF 7 21	ISO248016 FO-22EF 7 21
Grit: Medium Ref.# Head L mm Total L mm	ISO173014 TF-11 10 24	ISO173016 TF-12 10 22	ISO173018 TF-13 10 22	ISO173023 TF-14 9 22	ISO172012 TF-18 8 20	ISO171014 TF-20 7 21	ISO171016 TF-21 7 21	ISO170021 TF-22 5.5 19	ISO170018 TF-23 5 20	ISO170018 TF-31 4.5 19	ISO169011 TF-41 4 19	ISO170012 TF-42 4 19
Grit: Medium Ref.# Head L mm Total L mm	ISO170014 TF-43 4.5 19	ISO173014 TF-S11 10 22	ISO173016 TF-S12 9 20	ISO173014 TF-S20 7 19	ISO171016 TF-S21 7 19	ISO170021 TF-S22 5.5 17	ISO170018 TF-S23 5 17	ISO170018 TF-S31 4.5 17	ISO169011 TF-S41 4 17	ISO170018 TF-SS21 7 18	ISO170016 TF-SS31 4.5 14.5	ISO173016 TF-L12 10 24

Grit: Super Fine Ref.# Head L mm Total L mm	TR-L14	TR-11	TR-12	TR-13	TR-14	TR-15	TR-19	TR-20	TR-21	TR-22	TR-24	TR-25
	9 24	10 22	10 22	9 22	9 24	11.5 24	11.5 21	7 21	7 20	8 21	7 21	10 21.5

Grit: Super Fine Ref.# Head L mm Total L mm	TR-26	TR-S11	TR-S12	TR-S20	TR-S21	TR-S22	TR-S23	TR-S31	TR-S41	TR-SS21	TR-SS31	TR-L12
	8.5 21.5	9 20	9 20	7 19	7 19	5.5 17	5 17	4.5 17	4 17	7 18	4.5 14.5	10 24

Grit: Super Fine Ref.# Head L mm Total L mm	TR-L14	SF-11	SF-12	SF-13	SF-20	SF-21	SF-22	SF-23	SF-24	SF-40	SF-41	SF-42
	8 24	8 22	8 22	7 21	7 21	7 21	7 21	7 21	7 21	4 19	4 19	4 19

Grit: Super Fine Ref.# Head L mm Total L mm	SF-43	SF-44	SF-45	SR-11	SR-12	SR-13	SR-20	SR-21	SR-22	SR-23	SR-24	SR-40
	4 19	4 19	4 19	8 22	8 22	8 22	7 21	7 21	7 21	7 21	7 21	4 19

Grit: Super Fine Ref.# Head L mm Total L mm	BR-25	BR-46	BR-S45	BR-S41	BR-S31	BR-L45	BR-L41	BR-L31	BR-L30	BR-L29	BC-31	BC-42
	2.9 19	1 16.5	1.2 16.5	1.4 16.5	1.8 22	1.2 22	1.4 22	1.8 22	2 22	2.3 22	3 19	2.4 19

Grit: Super Fine Ref.# Head L mm Total L mm	TC-10	TC-11	TC-20	TC-21	TC-26	TC-S21	TC-S26	SO-18	SO-20	SO-19	SO-22	SO-21
	10 22	10 22	8 20	8 22	6 21	6 20	6 20	6 21	6 21	6 21	8 22	8 22

Grit: Super Fine Ref.# Head L mm Total L mm	EX-12	FO-11	FO-12	FO-19	FO-20	FO-21	FO-22	FO-L31	FO-32	FO-31	FO-25	FO-27
	7 20	10 24	10 24	7 21	7 21	7 21	7 21	4 21	4 19	4 19	5 19	5 19

DW-11	DW-12	DW-13	DW-14	TH-11	TH-12	TH-13	TH-14	LG-12	LG-13	LG-14	LG-S21
1x3 24	1x3 24	1 19	1 19	7 20	8 22	10 22	7 20	10 22	9 22	9 22	7 19

TC-21C	SF-11C	SF-12C	SF-13C	SF-20C	SF-21C	SF-40C	SF-41C	SF-42C	SF-43C	SF-44C	SF-45C	SR-11C	SR-12C
8 22	8 22	8 22	8 22	7 21	7 21	4 19	4 19	4 19	4 19	4 19	4 19	8 22	8 22

BR-41C	SI-47C	SI-48C	WR-12C	WR-13C	EX-20C	EX-21C	CD-50F	CD-51F	CD-52F	CD-53F	CD-54F	CD-55F	CD-56F
1.4 19	1.8 19	1.8 19	1.5 19	1.5 19	2 19	2.5 19	0.6 16.5	0.6 16.5	0.6 16.5	2.5 16.5	2.5 16.5	1.2 16.5	2.5 16.5

FO-21F	FO-22F	FO-30F	EX-21F	BR-50F	BR-31F	WR-31F	WR-S31F	CR-11E	CR-12F	CR-21F	EX-17F	EX-18F	EX-01F
7 21	7 21	4 21	5 19	0.7 19	1.8 19	0.6 19	0.6 16.5	6 20	4 19	7 21.5	0.4 21	0.4 21	5 19

TF-11EF	TF-12EF	TF-21EF	TF-S21EF	TR-11EF	TR-12EF	TR-13EF	TR-21EF	TR-S21EF	TR-25EF	TR-26EF	SF-11EF	SF-21EF	SF41EF
10 24	10 22	7 21	7 19	10 22	10 22	9 22	7 21	7 19	10 21.5	8.5 21.5	8 22	7 21	4 19

FO-40EF	FO-42EF	EX-21EF	CR-11EF	CR-12EF	BR-40EF	BR-31H	EX-11H	FO-32H	TF-12H	SF-11H	SR-11H	EX-20H	WR-12H
4.5 23.5	8 22	5 19	6 20	4 19	1.6 19	1.8 19	5 19	4 19	10 22	8 22	8 22	5 19	1.5 19

Extra Coarse 181µm
 Coarse 151µm
 Medium 125µm
 Fine 60µm
 Super Fine 28µm
 Ultra Fine 8µm



Diamond Bur

Green MOUNTED STONE												
G1	G16	Gs16	Gs13 Pc2	G8	G9	G10	G11	G19	G20	G21	G22	G23
PINK MOUNTED STONE												
G1	G16	Gs16	Gs13 Pc2	G8	G9	G10	G11	G19	G20	G21	G22	G23
WHITE MOUNTED STONE												
G1	G16	Gs16	Gs13 Pc2	G8	G9	G10	G11	G19	G20	G21	G22	G23

Diamond Bur



DI052-6 56 holes for endo file
49 holes for FG handle
67 holes for RA handle
6 silicone cup

DI052-7 56 holes for endo file
98 holes for FG handle
66 holes for RA handle

DI052-8 60 holes for endo file
60 holes for FG handle

DI052-9 60 holes for endo file
60 holes for FG handle
4 Silicone cup

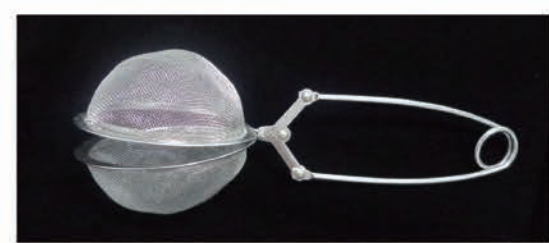

Clip Mesh Holder

- DI050**
- Material:
 - Autoclave
 - Package: 2pcs/box

Aluminum Bur Block

DI051-1 10 holes for RA handle
20 holes for FG handle

DI051-2 30 holes for FG handle

DI051-3 18 holes for endo file
10 holes for FG handle

DI052-1 36 holes for FG handle
36 holes for Endo file

DI052-2 30 holes for endo file
30 holes for FG handle
4 silicone cup

DI052-3 24 holes for endo file
24 holes for FG handle
24 holes for RA handle

Plastic Bur Block Autoclave

DI053-1 20 holes for FG handle
4 holes for RA handle

DI053-2 16 holes For FG handle

DI054 48 holes for HP handle

DI055 10 holes for FG handle
50 holes for RA handle

DI056 24 holes for FG Handle

DI057 Autoclave

Magnetic Bur Holder



Polishing Brush

Brass wire PP001 Ø 25.4mm 22mm 19mm 17.4mm 14.2mm	Steel wire PP002 Ø 25.4mm 22mm 19mm	Stainless Steel PP003 Ø 25.4mm 22mm 19mm 17.4mm 14.2mm	White wool PP004 Ø 25.4mm 22mm 19mm 17.4mm 14.2mm	Flower wool PP005 Ø 25.4mm 22mm 19mm 17.4mm 14.2mm	Black horse-tail PP006 Ø 25.4mm 22mm 19mm 17.4mm 14.2mm
Flower horse PP007 Ø 25.4mm 22mm 19mm	Black bristle PP008 Ø 25.4mm 22mm 19mm 17.4mm 14.2mm	White bristle PP009 Ø 25.4mm 22mm 19mm	White horse hair PP010 Ø 19mm 17.4mm 14.2mm	Mixing Wool PP011 Ø 19mm 17.4mm 14.2mm	Silicon carbide PP012 Ø 22mm
Tree wires PP013 Ø 28mm 25mm 22mm	Wool six angle PP014 Ø 22mm 19mm	Horse tail six angle PP015 Ø 22mm 19mm	Bristle six angle PP016 Ø 22mm 19mm	Bristle eight angle PP017 Ø 22mm	Bristle eight angle PP018 Ø 22mm
Wool felt PP019 Ø 22mm	Soft wool felt PP020 Ø 22mm	Wool felt PP021 Ø 22mm	Wool felt PP022 Ø 22mm	Sheep leather PP023 Ø 22mm	White cotton PP024 Ø 22mm
Yellow cotton PP025 Ø 22mm	Sheep leather PP026 Ø 22mm	Cloth PP027 Ø 22mm	Soft wool PP028 Ø 22mm	Cow leather PP029 Ø 22mm	Cow leather PP030 Ø 22mm
Wool felt PP031 Ø 22mm	Wool felt PP032 1 2 3 4 5 6 7 8		Flower wool with leather PP033	White wool brush PP034	Leather Cotton Thread PP035

Diamond Discs

 THICKNESS IN mm	Ref.#: DS001/13 0.15mm 0.20mm 0.25mm 0.30mm 0.35mm	Ref.#: DS001/16 0.15mm 0.20mm 0.25mm 0.30mm 0.35mm	Ref.#: DS001/19 0.15mm 0.20mm 0.25mm 0.30mm 0.35mm	Ref.#: DS001/22 0.15mm 0.20mm 0.25mm 0.30mm 0.35mm	Ref.#: DS001/24 0.20mm 0.25mm 0.30mm 0.35mm	
 THICKNESS IN mm	Ref.#: DS002/13 0.15mm 0.20mm 0.25mm	Ref.#: DS002/16 0.15mm 0.20mm 0.25mm	Ref.#: DS002/19 0.15mm 0.20mm 0.25mm	Ref.#: DS002/22 0.15mm 0.20mm 0.25mm	Ref.#: DS002/24 0.20mm 0.25mm	
 THICKNESS IN mm	Ref.#: DS003/16 0.15mm 0.20mm 0.25mm 0.30mm 0.35mm	Ref.#: DS003/19 0.15mm 0.20mm 0.25mm 0.30mm 0.35mm	Ref.#: DS003/22 0.15mm 0.20mm 0.25mm 0.30mm 0.35mm	Ref.#: DS003/24 0.20mm 0.25mm 0.30mm 0.35mm		
 THICKNESS IN mm	Ref.#: DS004/16 0.15mm 0.20mm 0.25mm 0.30mm 0.35mm	Ref.#: DS004/19 0.15mm 0.20mm 0.25mm 0.30mm 0.35mm	Ref.#: DS004/22 0.15mm 0.20mm 0.25mm 0.30mm 0.35mm	Ref.#: DS004/24 0.20mm 0.25mm 0.30mm 0.35mm		
 THICKNESS IN mm	Ref.#: DS005/16 0.15mm 0.20mm 0.25mm 0.30mm 0.35mm	Ref.#: DS005/19 0.15mm 0.20mm 0.25mm 0.30mm 0.35mm	Ref.#: DS005/22 0.15mm 0.20mm 0.25mm 0.30mm 0.35mm	Ref.#: DS005/24 0.15mm 0.20mm 0.25mm 0.30mm 0.35mm	Ref.#: DS005/35 0.15mm 0.20mm 0.25mm 0.30mm 0.35mm	Ref.#: DS005/40 0.15mm 0.20mm 0.25mm 0.30mm 0.35mm



DOUBLE SIDED
THICKNESS IN mm

Ref.#:	DS006/16	DS006/19	DS006/22	DS006/24	DS006/35	DS006/40
	0.15mm	0.15mm	0.15mm	0.15mm	0.15mm	
	0.20mm	0.20mm	0.20mm	0.20mm	0.20mm	0.20mm
	0.25mm	0.25mm	0.25mm	0.25mm	0.25mm	0.25mm
	0.30mm	0.30mm	0.30mm	0.30mm	0.30mm	0.30mm
	0.35mm	0.35mm	0.35mm	0.35mm	0.35mm	0.35mm



ONE SIDED
THICKNESS IN mm

Ref.#:	DS007/16	DS007/19	DS007/22	DS007/24
	0.20mm	0.20mm	0.20mm	0.20mm
	0.25mm	0.25mm	0.25mm	0.25mm



DOUBLE SIDED
THICKNESS IN mm

Ref.#:	DS008/19	DS008/22	DS008/24	DS009/19	DS009/22	DS009/24
	0.15mm	0.15mm	0.15mm	0.15mm	0.15mm	0.15mm
	0.20mm	0.20mm	0.20mm	0.20mm	0.20mm	0.20mm
	0.25mm	0.25mm	0.25mm	0.25mm	0.25mm	0.25mm
	0.30mm	0.30mm	0.30mm	0.30mm	0.30mm	0.30mm
	0.35mm	0.35mm	0.35mm	0.35mm	0.35mm	0.35mm



ONE SIDED
THICKNESS IN mm

Ref.#:	DS010/19	DS010/22	DS011/19	DS011/22
	0.15mm	0.15mm	0.15mm	0.15mm
	0.20mm	0.20mm	0.20mm	0.20mm
	0.25mm	0.25mm	0.25mm	0.25mm



DOUBLE SIDED
THICKNESS IN mm

Ref.#:	DS012/19	DS012/22	DS012/24	DS012/35	DS012/40
	0.15mm	0.15mm	0.15mm	0.15mm	0.15mm
	0.20mm	0.20mm	0.20mm	0.20mm	0.20mm
	0.25mm	0.25mm	0.25mm	0.25mm	0.25mm
	0.30mm	0.30mm	0.30mm	0.30mm	0.30mm
	0.35mm	0.35mm	0.35mm	0.35mm	0.35mm



DOUBLE SIDED
THICKNESS IN mm

Ref.#:	DS013/19	DS013/22	DS013/24	DS013/35	DS013/40
	0.15mm	0.15mm	0.15mm	0.15mm	0.15mm
	0.20mm	0.20mm	0.20mm	0.20mm	0.20mm
	0.25mm	0.25mm	0.25mm	0.25mm	0.25mm
	0.30mm	0.30mm	0.30mm	0.30mm	0.30mm
	0.35mm	0.35mm	0.35mm	0.35mm	0.35mm



DOUBLE SIDED
THICKNESS IN mm

Ref.#:	DS014/19	DS014/22	DS014/24
	0.15mm	0.15mm	0.15mm
	0.20mm	0.20mm	0.20mm
	0.25mm	0.25mm	0.25mm
	0.30mm	0.30mm	0.30mm
	0.35mm	0.35mm	0.35mm



DOUBLE SIDED
THICKNESS IN mm

Ref.#:	DS015/19	DS015/22	DS015/24	DS015/35	DS015/40
	0.15mm	0.15mm	0.15mm	0.15mm	0.15mm
	0.20mm	0.20mm	0.20mm	0.20mm	0.20mm
	0.25mm	0.25mm	0.25mm	0.25mm	0.25mm
	0.30mm	0.30mm	0.30mm	0.30mm	0.30mm
	0.35mm	0.35mm	0.35mm	0.35mm	0.35mm



DOUBLE SIDED
THICKNESS IN mm

Ref.#:	DS016/16	DS016/19	DS016/22	DS016/24
	0.15mm	0.15mm	0.15mm	0.20mm
	0.20mm	0.20mm	0.20mm	0.20mm
	0.25mm	0.25mm	0.25mm	0.25mm
	0.30mm	0.30mm	0.30mm	0.30mm
	0.35mm	0.35mm	0.35mm	0.35mm



Diamond Discs



Ref.#:	DS017/19	DS017/22	DS018/19	DS018/22	DS019/19	DS019/22
	0.15mm	0.15mm	0.15mm	0.15mm	0.15mm	0.15mm
	0.20mm	0.20mm	0.20mm	0.20mm	0.20mm	0.20mm
	0.25mm	0.25mm	0.25mm	0.25mm	0.25mm	0.25mm
			0.30mm	0.30mm	0.30mm	0.30mm
			0.35mm	0.35mm	0.35mm	0.35mm

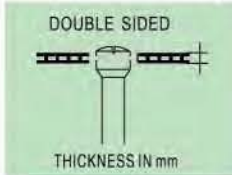

Ref.#:	DS020/19	DS020/22	DS020/24	DS020/35	DS020/40
	0.15mm	0.15mm	0.15mm	0.15mm	0.15mm
	0.20mm	0.20mm	0.20mm	0.20mm	0.20mm
	0.25mm	0.25mm	0.25mm	0.25mm	0.25mm
	0.30mm	0.30mm	0.30mm	0.30mm	0.30mm
	0.35mm	0.35mm	0.35mm	0.35mm	0.35mm

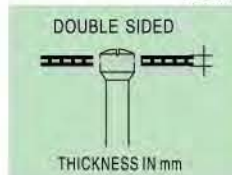

Ref.#:	DS021/19	DS021/22	DS021/24	DS021/35	DS021/40
	0.15mm	0.15mm	0.15mm	0.15mm	0.15mm
	0.20mm	0.20mm	0.20mm	0.20mm	0.20mm
	0.25mm	0.25mm	0.25mm	0.25mm	0.25mm
	0.30mm	0.30mm	0.30mm	0.30mm	0.30mm
	0.35mm	0.35mm	0.35mm	0.35mm	0.35mm

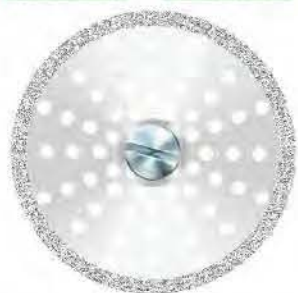
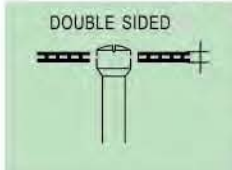

Ref.#:	DS022/40
	0.20mm
	0.25mm
	0.30mm
	0.35mm

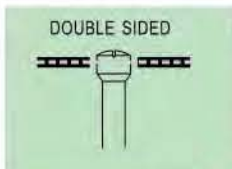

Dental Rotary



Dental Laboratory

Rubber Diamond Polishers -Special for zirconia/porcelain workpiece

Material: diamond frits mixing with synthetic rubber

Usage:For smoothing and polishing zirconia inner crown,zirconia veneer/porcelain teeth fast super bright.

(Avoid the color different and porcelain fragile caused by second glaze and baking.And it also can save time)

Caution:Please use the products in allowed RPM.Or it may take the products damaged!



Grit :	Extra Coarse	Medium Coarse	Fine	Extra Fine	Ultra Fine
Packing(pos):	1	1	1	1	1
Order No. :	RD001-1	RD001-3	RD001-4	RD001-5	RD001-6
Recommended R.P.M.:	15,000-25,000 / min	15,000-25,000 / min	15,000-25,000 / min	10,000-20,000 / min	10,000-20,000 / min
Size Φ × L(mm):	26 x 3	26 x 3	26 x 3	26 x 3	26 x 3
ISO No. : 802...	900 307 544 260	900 307 524 260	900 307 514 260	900 307 504 260	900 307 494 260



Grit :	Mid-Coarse	Fine	Ultra Fine	Ultra Fine	Ultra Fine	
Packing(pos):	1	1	1	1	1	
Order No. :	RD204-3	RD208-3	RD210-3	RD204-4	RD208-4	RD210-4
Recommended R.P.M.:		15,000-25,000 / min			15,000-25,000 / min	
Size Φ × L(mm):	4 x 12	12 x 2	12 x 2	4 x 12	12 x 2	12 x 2
ISO No. : 802...	104 243 524 040	104 041 524 120	104 304 524 120	104 243 514 040	104 041 514 120	104 304 514 120



Grit :	Extra Fine	Ultra Fine	Ultra Fine	Ultra Fine	Ultra Fine	
Packing(pos):	1/12	1/12	1/12	1/12	1/12	
Order No. :	RD204-5	RD208-5	RD210-5	RD204-6	RD208-6	RD210-6
Recommended R.P.M.:		10,000-20,000 / min			10,000-20,000 / min	
Size Φ × L(mm):	4 x 12	12 x 2	12 x 2	4 x 12	12 x 2	12 x 2
ISO No. : 802...	104 243 504 040	104 041 504 120	104 304 504 120	104 243 494 040	104 041 494 120	104 304 494 120

Rubber Polishers - Special for Non-precious and semi-precious metal workpiece

Material: synthetic rubber mixing with normal abrasive

Usage: For finishing and polishing alloy dental workpiece, such as for steel teeth/inner crown/steel frame/steel base finishing, smoothing and polishing.

Grit: Extra Coarse Packing(pcs): 100 Order No. : Recommended R.P.M. Size $\Phi \times L$ (mm): ISO No. : 802...						
	20,000-30,000 / min			20,000-30,000 / min		
	22 x 3	22 x 3.5	6 x 23	22 x 3	22 x 3.5	6 x 23
	900 372 544 220	900 303 544 220	900 114 544 060	900 372 534 220	900 303 534 220	900 114 534 060
	Grit: Middle Coarse					
	Packing(pcs): 100					
Grit: Middle Coarse Packing(pcs): 100 Order No. : Recommended R.P.M. Size $\Phi \times L$ (mm): ISO No. : 802...						
	20,000-30,000 / min			10,000-20,000 / min		
	22 x 3	22 x 3.5	6 x 23	22 x 3	22 x 3.5	6 x 23
	900 372 524 220	900 303 524 220	900 114 524 060	900 372 514 220	900 303 514 220	900 114 514 060
	Grit: Coarse					
	Packing(pcs): 12/100					
Grit: Coarse Packing(pcs): 12/100 Order No. : Recommended R.P.M. Size $\Phi \times L$ (mm): ISO No. : 802...						
	20,000-35,000 / min					
	5 x 16	3 x 7	4 x 12	6 x 16	12 x 2	15 x 2
	104 292 534 050	104 243 534 030	104 243 534 040	104 243 534 060	104 304 534 120	104 303 534 150
	Grit: Fine					
	Packing(pcs): 1					
Grit: Fine Packing(pcs): 1 Order No. : Recommended R.P.M. Size $\Phi \times L$ (mm): ISO No. : 802...						
	10,000-20,000 / min					
	5 x 16	3 x 7	4 x 12	6 x 16	12 x 2	15 x 2
	104 292 514 050	104 243 514 030	104 243 514 040	104 243 514 060	104 304 514 120	104 303 514 150
	Grit: Extra Fine					
	Packing(pcs): 1					
Grit: Extra Fine Packing(pcs): 1 Order No. : Recommended R.P.M. Size $\Phi \times L$ (mm): ISO No. : 802...						
	10,000-12,000 / min					
	5 x 16	3 x 7	4 x 12	6 x 16	12 x 2	15 x 2
	104 292 504 050	104 243 504 030	104 243 504 040	104 243 504 060	104 304 504 120	104 303 504 150
	Grit: Ultra Fine					
	Packing(pcs): 12/100					
Grit: Ultra Fine Packing(pcs): 12/100 Order No. : Recommended R.P.M. Size $\Phi \times L$ (mm): ISO No. : 802...						
	10,000-12,000 / min					
	5 x 16	3 x 7	4 x 12	6 x 16	12 x 2	15 x 2
	104 292 494 050	104 243 494 030	104 243 494 040	104 243 494 060	104 304 494 120	104 303 494 150

Silicone Diamond Polishers

-Special for resin teeth/hidden artificial teeth

Grit: Extra Fine Packing(pcs): 1 Order No. : Recommended R.P.M. Size $\Phi \times L$ (mm): ISO No. : 802...						
	8,000-10,000 / min			8,000-10,000 / min		
	22 x 3	12 x 1	4 x 12	22 x 3	12 x 1	4 x 12
	900 372 504 220	104 371 504 120	104 243 504 040	900 372 494 220	104 371 494 120	104 243 494 040

Silicone Polishers

-Special for porcelain/resin teeth

Grit: Coarse Packing(pcs): 100 Order No. : Recommended R.P.M. Size $\Phi \times L$ (mm): ISO No. : 802...									
	15,000-30,000 / min								
	16 x 2	22 x 3	22 x 3.5	6 x 23					
	900 303 534 160	900 372 54 220	900 303 534 220	900 114 534 060					
	Grit: Mid-Coarse								
	Packing(pcs): 1								
Grit: Mid-Coarse Packing(pcs): 1 Order No. : Recommended R.P.M. Size $\Phi \times L$ (mm): ISO No. : 802...									
	10,000-12,000 / min								
	16 x 2	22 x 3	22 x 3.5	6 x 23					
	900 303 524 160	900 372 524 220	900 303 524 220	900 114 524 060					
	Grit: Fine								
	Packing(pcs): 100								
Grit: Fine Packing(pcs): 100 Order No. : Recommended R.P.M. Size $\Phi \times L$ (mm): ISO No. : 802...									
	10,000-12,000 / min								
	16 x 2	22 x 3	22 x 3.5	6 x 23					
	900 303 514 160	900 372 514 220	900 303 514 220	900 114 514 060					
	Grit: Coarse								
	Packing(pcs): 12/100								
Grit: Coarse Packing(pcs): 12/100 Order No. : Recommended R.P.M. Size $\Phi \times L$ (mm): ISO No. : 802...									
	15,000-30,000 / min			10,000-20,000 / min			10,000-20,000 / min		
	4 x 12	4 x 12	12 x 2	4 x 12	4 x 12	12 x 2	4 x 12	4 x 12	12 x 2
	104 243 534 040	104 174 534 040	104 041 534 120	104 243 524 040	104 174 524 040	104 041 524 120	104 243 514 040	104 174 514 040	104 041 514 120

Opal-separafing Discs



Packing(pcs):	100	
Order No.:	SD001-1	SD001-2
Recommended R.P.M.:	12000 / min	15000 / min
Size $\Phi \times T$ (mm):	22x0.2	38x0.6
ISO No.:	652...	900 371 514 220 900 371 514 380

Silicone Polishers

-Special for resin base

Grit:	Extra Coarse						
Packing(pcs):	12/100						
Order No.:	PS212-1	PS213-1	PS214-1	PS215-1	PS216-1	PS217-1	PS218-1
Recommended R.P.M.:	20,000-30,000 / min			15,000-20,000 / min			
Size $\Phi \times L$ (mm):	6 x 16	10 x 20	10 x 24	10 x 17	13 x 20	14 x 17	15 x 17
ISO No.:	802...	104 243 544 060	104 300 544 100	104 275 544 100	104 237 544 100	104 292 544 130	104 012 544 140 104 145 544 150

Grit:	Coarse						
Packing(pcs):	12/100						
Order No.:	PS212-2	PS213-2	PS214-2	PS215-2	PS216-2	PS217-2	PS218-2
Recommended R.P.M.:	20,000-30,000 / min			15,000-20,000 / min			
Size $\Phi \times L$ (mm):	6 x 16	10 x 20	10 x 24	10 x 17	13 x 20	14 x 17	15 x 17
ISO No.:	802...	104 243 534 060	104 300 534 100	104 275 534 100	104 237 534 100	104 292 534 130	104 012 534 140 104 145 534 150

Grit:	Mid-Coarse						
Packing(pcs):	12/100						
Order No.:	PS212-3	PS213-3	PS214-3	PS215-3	PS216-3	PS217-3	PS218-3
Recommended R.P.M.:	10000-20,000 / min						
Size $\Phi \times L$ (mm):	6 x 16	10 x 20	10 x 24	10 x 17	13 x 20	14 x 17	15 x 17
ISO No.:	802...	104 243 524 060	104 300 524 100	104 275 524 100	104 237 524 100	104 292 524 130	104 012 524 140 104 145 524 150

Grit:	Extra Fine						
Packing(pcs):	12/100						
Order No.:	PS212-5	PS213-5	PS214-5	PS215-5	PS216-5	PS217-5	PS218-5
Recommended R.P.M.:	10,000-15,000 / min			8,000-12,000 / min			
Size $\Phi \times L$ (mm):	6 x 16	10 x 20	10 x 24	10 x 17	13 x 20	14 x 17	15 x 17
ISO No.:	802...	104 243 504 060	104 300 504 100	104 275 504 100	104 237 504 100	104 292 504 130	104 012 504 140 104 145 504 150

Ceramic Diamond Grinder - Special for zirconia

Grit:	Mid-Coarse								
Packing(pcs):	1								
Order No.:	PC003-3	PC004-3	PC005-3	PC007-3	PC201-3	PC202-3	PC203-3	PC204-3	PC205-3
Recommended R.P.M.:	15,000-30,000 / min								
Size $\Phi \times L$ (mm):	22 x 2	16 x 3.5	22 x 4.5	22 x 2	5 x 12	4 x 10.5	3 x 7	12 x 2	12 x 3
ISO No.:	802...	900 372 524 220	900 041 524 160	900 041 524 220	900 307 524 220	104 113 524 050	104 174 524 040	104 197 524 030	104 041 524 120 104 042 524 120

Ceramic Grinder - Special for alloy workpiece

Grit:	Coarse									
Packing(pcs):	1									
Order No.:	PC221-2	PC222-2	PC223-2	PC224-2	PC225-2	PC226-2	PC227-2	PC228-2	PC229-2	PC230-2
Recommended R.P.M.:	15,000-30,000 / min					15,000-30,000 / min				
Size $\Phi \times L$ (mm):	5 x 12	5 x 16	3.5 x 10.5	12.5 x 3.5	13 x 1.5	5 x 12	5 x 16	3.5 x 10.5	12.5 x 3.5	13 x 1.5
ISO No.:	802...	104 113 533 050	104 292 533 050	104 173 533 035	104 024 533 125	104 041 533 130	104 113 533 050	104 292 533 050	104 173 533 035	104 024 533 125 104 041 533 130

Dental Clinic

Rubber Diamond Polishers -Special for dental clinic porcelain and zirconia

Grit:	Mid-Coarse						Fine		Extra Fine	
Packing(pcs):	6/12/100									
Order No.:	RD114-3	RD115-3	RD114-4	RD115-4	RD114-5	RD115-5				
Recommended R.P.M.:	15,000-25,000 / min			15,000-20,000 / min		10,000-15,000 / min				
Size $\Phi \times L$ (mm):	3 x 7	5 x 10	3 x 7	5 x 10	3 x 7	5 x 10				
ISO No.:	802...	314 243 524 030	314 243 524 050	314 243 514 030	314 243 514 050	314 243 504 030	314 243 504 050			

Grit:	Mid-Coarse					
Packing(pcs):	6/12/100					
Order No.:	RD312-3	RD314-3	RD316-3	RD317-3	RD318-3	RD310-3
Recommended R.P.M.:	15,000-25,000 / min					
Size $\Phi \times L$ (mm):	3 x 7	5 x 10	6 x 9.5	9 x 8.5	10 x 1	10 x 1.8
ISO No.:	802...	204 243 524 030	204 243 524 050	204 030 524 060	204 030 524 090	204 371 524 100 204 304 524 100

Grit:	Fine					
Packing(pcs):	6/12/100					
Order No.:	RD312-4	RD314-4	RD316-4	RD317-4	RD318-4	RD310-4
Recommended R.P.M.:	15,000-20,000 / min					
Size $\Phi \times L$ (mm):	3 x 7	5 x 10	6 x 9.5	9 x 8.5	10 x 1	10 x 1.8
ISO No.:	802...	204 243 514 030	204 243 514 050	204 030 514 060	204 030 514 090	204 371 514 100 204 304 514 100

Grit : Extra Fine
Packing(pcs): 6/12/100
Order No. : RD312-5 RD314-5 RD316-5 RD317-5 RD318-5 RD310-5
Recommended R.P.M.: 10,000-15,000 / min
Size $\Phi \times L$ (mm): 3 x 7 5 x 10 6 x 9.5 9 x 8.5 10 x 1 10 x 1.8
ISO No. : 802... 204 243 504 030 204 243 504 050 204 030 504 060 204 030 504 090 204 371 504 100 204 304 504 100

Rubber Polishers -Special for dental clinic Non-precious and semi-Precious metal

Grit : Coarse
Packing(pcs): 6/12/100
Order No. : PR120-2 PR121-2 PR120-4 PR121-4 PR120-5 PR121-5 PR120-6 PR121-6
Recommended R.P.M.: 10,000-15,000 / min 10,000-15,000 / min 10,000-15,000 / min 10,000-15,000 / min
Size $\Phi \times L$ (mm): 3 x 7 5 x 10 3 x 7 5 x 10 3 x 7 5 x 10 3 x 7 5 x 10
ISO No. : 652... 314 243 534 030 314 243 534 050 314 243 514 030 314 243 514 050 314 243 514 030 314 243 514 050 314 243 514 030 314 243 514 050

Grit : Coarse
Packing(pcs): 6/12/100
Order No. : PR322-2 PR324-2 PR326-2 PR327-2 PR328-2 PR310-2
Recommended R.P.M.: 10,000-15,000 / min
Size $\Phi \times L$ (mm): 3 x 7 5 x 10 6 x 9.5 9.5 x 8 10 x 1 10 x 1.8
ISO No. : 652... 204 243 534 030 204 243 534 050 204 030 534 060 204 030 534 090 204 371 534 100 204 304 534 100

Grit : Fine
Packing(pcs): 6/12/100
Order No. : PR322-4 PR324-4 PR326-4 PR327-4 PR328-4 PR310-4
Recommended R.P.M.: 10,000-15,000 / min
Size $\Phi \times L$ (mm): 3 x 7 5 x 10 6 x 9.5 9.5 x 8 10 x 1 10 x 1.8
ISO No. : 652... 204 110 514 030 204 243 514 050 204 030 514 060 204 030 514 090 204 371 514 100 204 304 514 100

Grit : Extra Fine
Packing(pcs): 6/12/100
Order No. : PR322-5 PR324-5 PR326-5 PR327-5 PR328-5 PR310-5
Recommended R.P.M.: 10,000-15,000 / min
Size $\Phi \times L$ (mm): 3 x 7 5 x 10 6 x 9.5 9.5 x 8 10 x 1 10 x 1.8
ISO No. : 652... 204 243 504 030 204 243 504 050 204 030 504 060 204 030 504 090 204 371 504 100 204 304 504 100

Grit : Ultra Fine
Packing(pcs): 6/12/100
Order No. : PR322-6 PR324-6 PR326-6 PR327-6 PR328-6 PR310-6
Recommended R.P.M.: 10,000-12,000 / min
Size $\Phi \times L$ (mm): 3 x 7 5 x 10 6 x 9.5 9.5 x 8 10 x 1 10 x 1.8
ISO No. : 652... 204 243 494 030 204 243 494 050 204 030 494 060 204 030 494 090 204 371 494 100 204 304 494 100

Silicone Polishers -Special for dental clinic porcelain and resin.

Grit : Coarse Mid-Coarse Fine
Packing(pcs): 6/12/100
Order No. : PS123-2 PS124-2 PS123-3 PS124-3 PS123-4 PS124-4
Recommended R.P.M.: 10,000-15,000 / min 10,000-15,000 / min 10,000-15,000 / min
Size $\Phi \times L$ (mm): 3 x 7 5 x 10 3 x 7 5 x 10 3 x 7 5 x 10
ISO No. : 658... 314 243 534 030 314 243 534 050 314 243 524 030 314 243 524 050 314 243 514 030 314 243 514 050

Grit : Coarse
Packing(pcs): 6/12/100
Order No. : PS323-2 PS324-2 PS326-2 PS327-2 PS328-2 PS310-2
Recommended R.P.M.: 10,000-15,000 / min
Size $\Phi \times L$ (mm): 3 x 7 5 x 10 6 x 9.5 9.5 x 8 10 x 1 10 x 1.8
ISO No. : 658... 204 243 534 030 204 243 534 050 204 030 534 060 204 030 534 090 204 371 534 100 204 304 534 100

Grit : Mid-Coarse
Packing(pcs): 6/12/100
Order No. : PS323-3 PS324-3 PS326-3 PS327-3 PS328-3 PS310-3
Recommended R.P.M.: 10,000-12,000 / min
Size $\Phi \times L$ (mm): 3 x 7 5 x 10 6 x 9.5 9.5 x 8 10 x 1 10 x 1.8
ISO No. : 658... 204 243 524 030 204 243 524 050 204 030 524 060 204 030 524 090 204 371 524 100 204 304 524 100

Grit : Fine
Packing(pcs): 6/12/100
Order No. : PS323-4 PS324-4 PS326-4 PS327-4 PS328-4 PS310-4
Recommended R.P.M.: 10,000-12,000 / min
Size $\Phi \times L$ (mm): 3 x 7 5 x 10 6 x 9.5 9.5 x 8 10 x 1 10 x 1.8
ISO No. : 658... 204 243 514 030 204 243 514 050 204 030 514 060 204 030 514 090 204 371 514 100 204 304 514 100

Silicone Plishers -Special for dental clinic precious metal

Grit : Coarse Mid-Coarse Fine
Packing(pcs): 6/12/100
Order No. : PS129-2 PS130-2 PS129-3 PS130-3 PS129-4 PS130-4
Recommended R.P.M.: 7,000-12,000 / min
Size $\Phi \times L$ (mm): 3 x 7 5 x 10 3 x 7 5 x 10 3 x 7 5 x 10
ISO No. : 658... 314 243 534 030 314 243 534 050 314 243 524 030 314 243 524 050 314 243 514 030 314 243 514 050

Dental Rotary

Grit : Coarse						
Packing(pcs): 6/12/100						
Order No. :	PS332-2	PS334-2	PS336-2	PS337-2	PS338-2	PS330-2
Recommended R.P.M.:			10,000-15,000 / min			
Size $\Phi \times L$ (mm):	3 x 7	5 x 10	6 x 9.5	9.5 x 8	10 x 1	10 x 1.8
ISO No. : 802...	204 243 534 030	204 243 534 050	204 030 534 060	204 030 534 090	204 371 534 100	204 304 534 100

Grit : Mid-coarse						
Packing(pcs): 6/12/100						
Order No. :	PS332-3	PS334-3	PS336-3	PS337-3	PS338-3	PS330-3
Recommended R.P.M.:			10,000-15,000 / min			
Size $\Phi \times L$ (mm):	3 x 7	5 x 10	6 x 9.5	9.5 x 8	10 x 1	10 x 1.8
ISO No. : 802...	204 243 524 030	204 243 524 050	204 030 524 060	204 030 524 090	204 371 524 100	204 304 524 100

Grit : Fine						
Packing(pcs): 6/12/100						
Order No. :	PS332-4	PS334-4	PS336-4	PS337-4	PS338-4	PS330-4
Recommended R.P.M.:			7,000-12,000 / min			
Size $\Phi \times L$ (mm):	3 x 7	5 x 10	6 x 9.5	9.5 x 8	10 x 1	10 x 1.8
ISO No. : 802...	204 243 514 030	204 243 514 050	204 030 514 060	204 030 514 090	204 371 514 100	204 304 514 100

Ceramic Diamond Grinder -Special for zirconia

Grit : Coarse		
Packing(pcs): 6/12/100		
Order No. :	PC329-3	PC331-3
Recommended R.P.M.:		7,000-10,000 / min
Size $\Phi \times L$ (mm):	2.8 x 7	3 x 7
ISO No. : 802...	204 161 523 028	204 273 523 030

Ceramic Grinder -Special for dental clinic metal and resin

Grit : Fine				
Packing(pcs): 6/12/100				
Order No. :	PC132-4	PC133-4	PC336-4	PC337-4
Recommended R.P.M.:			7,000-10,000 / min	
Size $\Phi \times L$ (mm):	2.8 x 7	3 x 7	2.8 x 7	3 x 7
ISO No. : 802...	314 161 513 028	314 273 513 030	204 161 513 028	204 273 513 030

Zogear Dental Polishing kits



ID:RA1112

High Gloss Polishing RA1112 Kit for Composite
Used for low-speed
Usage Soft silicone polishers and diamond polishers for composite materials, preparation and high gloss polishing

Package: 12pcs/kit
4pcs white ceramic grinders: CW3064m *2pcs, CW3114m *2pcs
4pcs light blue silicone polishers: SH3114m, SH3144m, SH3414m, SH3204m
4pcs pink rubber diamond polisher: RD3117, RD3147, RD3417, RD3207



ID:RA3112

High Gloss Polishing RA3112 Kit for Full Zirconia Crown
Used for low-speed
Usage: Clinical intraoral high gloss polishing for zirconia case temper, form repair and after repair.

Package: 12pcs/kit
4pcs light yellow ceramic diamond grinders: CD3064 *2pcs, CD3114 *2pcs
4pcs light grey rubber diamond polishers: RD3114, RD3144, RD3414, RD3204
4pcs yellow rubber diamond polisher: RD3115, RD3145, RD3415, RD3205

Dental Rotary

ID:RA2112

High Gloss Polishing RA2112 Kit for Porcelain
Used for low-speed
Usage: Clinical intraoral high gloss polishing for zirconia case temper, form repair and after repair.

Package: 12pcs/kit
4pcs white ceramic grinders: CW3064m *2pcs, CW3114m *2pcs
4pcs pink silicone polishers: SH3113m, SH3143m, SH3413m, SH3203m
4pcs yellow rubber diamond polisher: RD3115, RD3145, RD3415, RD3205



ID:RA0309

Composite resin polishing kit RA 0309
Used for low-speed
Usage: Ceramic grinders and soft silicone polishers for composite materials, preparation and high gloss polishing.

Package: 9pcs/kit
3pcs white ceramic grinders: CW3064, CW3114, CW3514
3pcs pink silicone polishers: SH3203, SH3413, SH3133
3pcs light blue silicone polishers: SH3204, SH3414, SH3134



ID:RA0304

Polishing RA0304 Kit for Composite
Used for low-speed
Usage: Soft silicone polishers for porcelain

Package: 4pcs/kit
2pcs white silicone polishers: SH3132, SH3202
2pcs blue silicone polishers: SH3134, SH3204

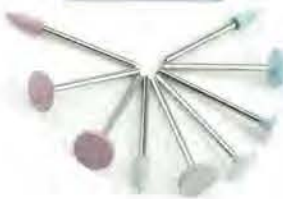

ID:HP0312

Porcelain denture polishing kits HP 0312 Used for low-speed Usage: Soft silicone polishers for composite materials, preparation and high gloss polishing.

Package: 12pcs/kit
6pcs white silicone polishers: SH2122 *2pcs, SH2412 *2, SH2322 *2
3pcs pink silicone polishers: SH2123, SH2413, SH2323
3pcs light blue silicone polishers: SH2124, SH2414, SH2324

ID:HP0207

High Gloss Polishing HP0207 Kit for Porcelain Used for Straight Handpiece

Usage: Diamondburs, soft silicone polisher and universal diamond polishers for porcelain

Package: 7pcs/kit
3pcs diamond Burs(HP): DD2392, DD2343, DD2323
2pcs light grey silicone polishers: SH2322, SH2122
2pcs yellow rubber diamond polishers: RD2325, RD2125



ID:HP0412

Resin bridgework polishing kits HP0412 Used for low-speed Usage: Soft silicone polishers for composite materials, preparation and high gloss polishing.

Package: 12pcs/kit
4pcs black silicone polishers: SK2132 *2pcs, SK2142, SK2022
4pcs green silicone polishers: SK2133 *2pcs, SK2143, SK2023
4pcs yellow silicone polishers: SK2135 *2pcs, SK2145, SK2025

ID:HP0406

High Gloss Polishing HP0406 Kit for Resin bridgework

Used for Laboratory Usage: Carbide burs, soft silicone polishers and universal diamond polishers for composite materials, preparation and high gloss polishing.

Package: 6pcs/kit
2pcs carbide bur(HP): TH805, TH803
2pcs light yellow silicone polishers: SK2135, SK2125
2pcs pink rubber diamond polishers: RD2127, RD2137



ID:HP0306

High Gloss Polishing HP0306 Kit for Full Zirconia Crown

Used for straight handpiece Usage: Ceramic diamond grinders and universal diamond polishers for zirconia case temper, form repair and after repair.

Package: 6pcs/kit
2pcs light yellow ceramic diamond grinders: CD2024, CD2124
2pcs grey rubber diamond polishers: RD2324, RD2124
2pcs yellow rubber diamond polishers: RD2325, RD2125

Cements & Liners

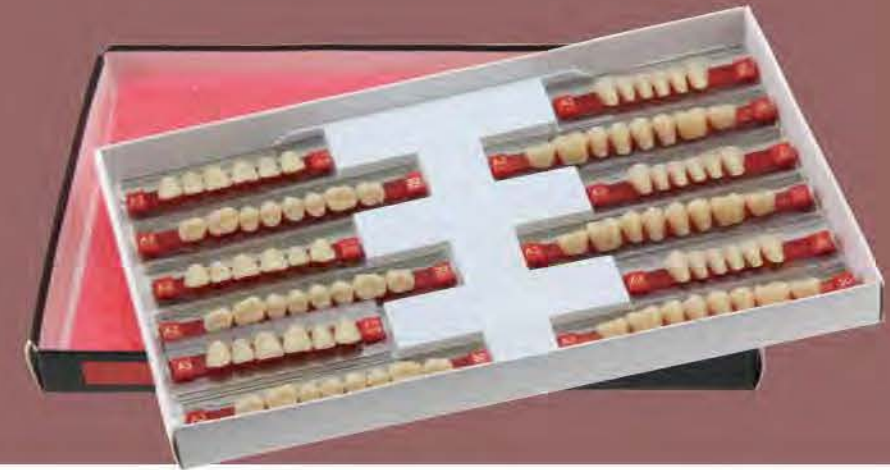

Synthetic Polymer Teeth



- 28X1,4X1,6X1,8X1
- We supply full shade and form polymer teeth, Base Vita 16, from A1 to D4
- 30 anteriors and 12 posteriors

Ref.#	Description	Package
TM001	One layer	5/24/16/12sets/box
TM002	Two layer	50boxes/ctn
TM003	Three layer	

Denture Base Resin Type I

heat-curing

- Shade: 2#,3#

Ref.#	Description	Package
TM004-1	100g powder	100bottles/ctn
TM004-2	500g powder	20bottles/ctn
TM004-3	100ml liquid	100bottles/ctn
TM004-4	500ml liquid	20bottles/ctn

Denture Base Resin Type II

self-curing

- Shade: 2#,3#

Ref.#	Description	Package
TM005-1	100g powder	100bottles/ctn
TM005-2	500g powder	20bottles/ctn
TM005-3	100ml liquid	100bottles/ctn
TM005-4	500ml liquid	20bottles/ctn

Fibred Denture Base Resin



Ref.#	Description	Package
TM006-1	100g powder	100bottles/ctn
TM006-2	500g powder	20bottles/ctn
TM006-3	100ml liquid	100bottles/ctn
TM006-4	500ml liquid	20bottles/ctn

Tooth Acrylic/Self-curing Tooth Acrylic



teeth.Shade:#0 transparent;
#1-#3 Light yellow

Ref.#	Description	Package
TM007-1	Tooth Acrylic 100g	10bags/ctn
TM007-2	Self-curing Tooth Acrylic 100g	40bottles/ctn

Self-curing Soft Liner Material



Ref.#	Description	Package
TM008	25g powder + 20ml	1set/box

Alginate Impressions



Ref.#	Description	Package
TM009-1	500g	500g/bag,20bags/ctn
TM009-2	1200g	1200g/barrel

Molding Composition



Ref.#	Description	Package
TM010	Red,225g	48boxes/ctn

Sheet Wax

Thickness
24#: 0.50mm
26#: 0.40-0.45mm
28#: 0.35mm
30#: 0.30mm



Ref.#	Description	Package
TM011	24#26#28#30#	30pcs/box 100box/ctn

Base Plate Wax



Ref.#	Description	Package
TM012-1	Red, ordinary 250g	50boxes/ctn
TM012-2	Red,tropical 250g	50boxes/ctn
TM012-3	Red,170X95X2 (500g)	30boxes/ctn

Inlay Wax



Ref.#	Description	Package
TM013	100g	100g/box

Dipping Wax



Ref.#	Description	Package
TM014	80g	80g/box

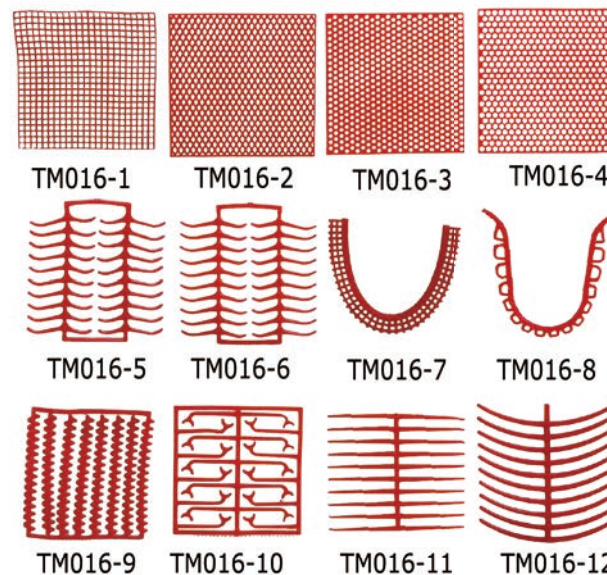

Wax for Crown & Bridge



Ref.#	Description	Package
TM015	80g	80g/box

Wax Patterns

With good plasticity,is suitable for making wax patterns for castings and casting various metal prostheses.

Ref.#	Description	Package
TM016-1/2/3/4	10X1	20pcs/box
TM016-5/6/7/8	10X1	10pcs/box
9/10/11/12		



Casting Wax Wire

Ref.#	Description	Package
TM017-1	Round (0.8,1.0,1.2,1.5,2.0)	50g/box
TM017-2	Round (2.5,3.0,3.5,4.0,5.0)	100g/box

Zinc-Phosphate Cement



Ref.#	Description	Package
TM018-1	30g powder/bottle, 15ml liquid/bottle	3sets/box 50box/ctn
TM018-2	30g powder/bottle	
TM018-3	15ml liquid/bottle	300bottles/ctn

Zinc Poly-carboxylate Cement



Ref.#	Description	Package
TM019-1	30g powder/bottle, 15ml liquid/bottle	1set/box 80box/ctn
TM019-2	30g powder/bottle	
TM019-3	15ml liquid/bottle	300bottles/ctn



Glass Ionomer Cement



Ref.#	Description	Package
TM020-1	20g powder/bottle, 15ml liquid/bottle	3sets/box 50box/ctn
TM020-2	20g powder/bottle	300bottles/ctn
TM020-3	15ml liquid/bottle	

Enhanced Glass Ionomer Cement



Ref.#	Description	Package
TM021-1	9g powder/bottle	1set/box
TM021-2	6ml liquid/bottle	100box/ctn
TM021-3	9g powder/bottle 6ml liquid/bottle	300bottles/ctn

Temporary Stoppings



Ref.#	Description	Package
TM022	100g	100boxes/ctn

Eugenol



Ref.#	Description	Package
TM023	20ml	100boxes/box

Eugenol Cement



Ref.#	Description	Package
TM024-1	2X10g powder+6ml liquid	90boxes/box
TM024-2	10g powder	
TM024-3	6ml liquid	

Dental Stone/Super-hard Dental Stone



Ref.#	Description	Package
TM025-1	Dental Stone 1KG	10bags/ctn
TM025-2	Super-hard 1KG	10bag/ctn

Amalgam Alloy



It is available in high silver alloy (69% of silver).

Ref.#	Description
TM026	Ag-69 25g

Silver Alloy Capsules



Ref.#	Description
TM027-1	Ag-43 200mg/capsule
TM027-2	Ag-43 400mg/capsule
TM027-3	Ag-43 600mg/capsule



Dental Alloy

TM028-1
ZGCAST NB, A high strength nickel chrome with beryllium alloy, used for dental ceramic restorations

TM028-2
ZGCAST NP, A biocompatible, beryllium-free, nickel chrome alloy as defined by 22674, for use with ceramic restorations

TM028-3
ZGCAST CC, A biocompatible, nickel & beryllium free, cobalt chrome alloy as defined by 22674, for use with ceramic restorations.

TM028-4
ZGCAST Soft, A nickel base alloy as defined by ISO22674 designed for the production of high quality full crowns, bridges, inlays, acrylics and composite restorations

TM028-5
ZGCAST TS, Nickel cobalt dental alloy, for restorations of removable framework and partial dentures

TM028-6
ZGCAST PS, A biocompatible cobalt chrome alloy, nickel & beryllium free, as defined by ISO22674, for restorations of removable framework and partial dentures.

	TM028-1	TM028-2	TM028-3	TM028-4	TM028-5	TM028-6	
composite	Nickel (%)	76	61	-	75	61	--
	Chrome(%)	15	25	25	5	16	29
	Molybdenum(%)	5	11	6	--	5	6
	Aluminium(%)	2	--	--	--	--	--
	Beryllium(%)	1.7	--	--	--	1.6	--
	others(%)	<3	<3	<3	<3	<3	<3
	Si(%)	--	1.5	--	--	--	--
	Cobalt(%)	--	--	61	--	8	64
	tungsten(%)	--	--	5	--	--	--
	cu	--	--	--	12.5	--	--
	sn	--	--	--	5.5	--	--
manganese	--	--	--	--	3.5	--	
Technical data	Melting Range	1232°C - 1288°C	1310°C - 1360°C	1290-1370°C	1230°C -1330°C	1270- 1320°C	1240- 1340°C
	Yield Strength	552 MPa	320 MPa	530 MPa	260MPa	500 MPa	520 MPa
	Elongation	11 %	8.3 (g/cc)	4%	19 %	5%	6%
	Density	7.9 (g/cc)	19%	8.5(g/cc)	8.4 (g/cc)	8.0 (g/cc)	8.3 (g/cc)
	Coefficient of the Liner Expansion (25-500°C)	13.8 X 10-6K-1	14.1 X 10-6K-1	14.1 X 10-6K-1	--	--	--
	Modulus of elasticity	--	--	--	--	230Gpa	220Gpa

Teeth Care Products



Super-velvet floss—satin thread structure PTFE material, satin thread structure, velvet, bear avulsion, and be easy to glide.



Magic dental floss will be full of you teeth and gum when using, which will clean completely.



XYLITOL floss can be suitable for more people, especially good for diabetic.

TC001

Available in:

- a: Waxed, Mint
- b: Natural (unwaxed, without flavour)
- c: Antibacterial (Waxed, without flavour)
- d: Whitening (Unwaxed, mint fluoride)

Varieties of Dental Floss Dispenser

Mini Pack (3M to 20M)



D221 D222 D223 D226

Regular Pack (15M to 50M)



D201 D202 D203 D205 D206

Premium Pack (15M to 50M)



D211 D212 D215

Large Pack (50M to 200M)



D231 D232

Credit Card Floss (10M to 50M)



Interdental Brushes

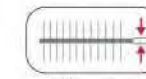

Wire size (diameter)

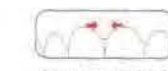

Passage hole diameter (PHD)

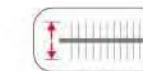

Bristle size (diameter)

	Pink	0.4mm	0.6mm	2.0mm
	Red	0.5mm	0.9mm	2.2mm
	Blue	0.6mm	1.1mm	2.5mm
	Yellow	0.7mm	1.3mm	3.0mm
	Green	0.8mm	1.6mm	3.5mm

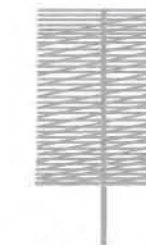

Cylindrical



Tapered



IB301

IB302

IB303

IB304

IB305

TC002

TC005

Tongue Scraper

Tongue Brush

Denture Brush

Interspace Brush



TC006-1

TC006-2

TC007-1

TC007-2

TC008-1

TC008-2

TC009

Teeth Care Products



Finger Brush

TC010

- Material: Silicone
- It is safe way to keep your baby's teeth and gums cleaner and healthier.



Dental Stain Remover

TC011

- It can clean plaques, tartar and food deposits easily on your teeth.



Orthodontic Kit



BOX
TC012



BAG

- *Orthodontic kit :
 - orthodontic toothbrush("V" shape bristle);
 - travel toothbrush("V" shape bristle);
 - orthodontix wax;
 - timer(2 minutes);
 - dental mirror;
 - Dental Floss(15m mint & waxed);
 - interdental brush;
 - Dental thread

Wax

TC013



Sand time

TC014

